

TRANSIT DEVELOPMENT DESIGN GUIDELINES

JUNE 2016

Prepared for

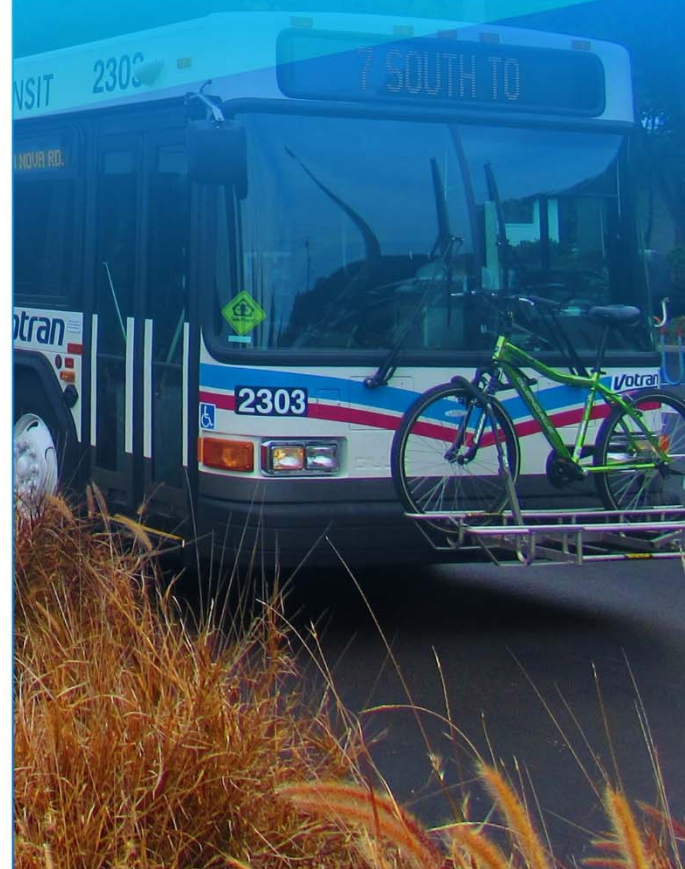

TABLE OF CONTENTS

Introduction	1
How to Use these Guidelines	1
Developers, Project Planners, Engineers, and Architects.....	2
Local Government Planners, Engineers, Planning Boards and Elected Officials	2
Incorporate the Principles into Plans and Regulations	2
Transit Corridors.....	3
Thresholds for Review	3
Regulatory Requirements for Inclusion	3
Design Standards.....	4
Crime Prevention Through Environmental Design.....	7
Bus Stop Sign & Pole.....	8
Design Standards & Facts	8
Positives	10
Negatives.....	10
Boarding & Alighting Area	11
Design Standards & Facts	11
Positives	12
Negatives.....	12
Bus Stop Shelters & Easements	13
Design Standards & Facts	13
Positives	16
Negatives.....	16
Benches & Bike Storage.....	17
Design Standards & Facts	17
Positives	18
Negatives.....	18
Bus Stop Landscaping, Lighting, and Trash Receptacles	19
Design Standards & Facts	19
Positives	20
Negatives.....	21

Sidewalk Connectivity, Paved Walkways, & Bike Lane Access	22
Design Standards & Facts	22
Positives	23
Negatives.....	23
Bus Bay/Pull Out & Bulb Outs.....	24
Design Standards & Facts	24
Positives	26
Negatives.....	26
Major Transfer Centers & Park-and-Rides	27
Design Standards & Facts	27
Positives	28
Negatives.....	28
Appendix A: Technical Design Standards for Accessible Bus Stops	29
Appendix B: Joint Development Agreement Template.....	83
Appendix C: Land Development Code Matrix.....	84
Appendix D: Supplemental Design Standards.....	96
Bus Bays	97
Bus Stop Sign & Pole.....	97
Appendix E: TIA Process Flowchart.....	98
Appendix F: Reference Sources	100

List of Tables

Table 1: Transit Infrastructure Recommendations	6
Table 2: Crime Prevention Through Environmental Design Standards	7
Table 3: Minimum Boardings Suggested by Location for Considering Bus Shelters	14
Table 4: Preferred Locations by Shelter Type	15
Table 5: Bus Bay Lengths and Speeds	25

List of Figures

Figure 1: Standard 40-Foot Bus Turning Radius.....	5
Figure 2: Votran Bus Stop Sign on Existing Pole.....	9
Figure 3: Votran Bus Stop Sign and Pole.....	9
Figure 4: Bus Stop Sign on Far Side of Sidewalk.....	9
Figure 5: Bus Stop Sign in Planting Strip	9
Figure 6: Bus Stop Sign on Near Side of Sidewalk.....	9
Figure 7: Bus Stop Sign (No Curb and Gutter).....	9

Figure 8: B&A with an adjacent bench	12
Figure 9: B&A area without a shelter or bench	12
Figure 10: B&A Configuration (Sidewalk Adjacent to Curb)	12
Figure 11: Votran B&A area.....	12
Figure 12: Example of Small Bus Shelter.....	15
Figure 13: Example of Mid-Sized Bus Shelter	15
Figure 14: Typical Bus Bench Dimensions.....	17
Figure 15: Bus Benches at Votran Transfer Point	17
Figure 16: Bicycle Rack Dimensions (Inverted “U” Bicycle Racks)	18
Figure 17: Example of Bus Stop Landscaping.....	19
Figure 18: Example of Trash Receptacle at Sheltered Bus Stop	20
Figure 19: Pedestrian Pathway to Votran bus stop.....	23
Figure 20: Minimum Bike Lane Width	23
Figure 21: Closed Bus Bay Example	25
Figure 22: Votran Closed Bus Bay Example	25
Figure 23: Example of Bus Bulb	26
Figure 24: Example of Typical Transfer Center	27
Figure 25: Votran’s DeLand Transfer Center.....	27
Figure 26: Example of Bus Facilities at Park-and-Ride	28
Figure 27: Saxon Boulevard Park-and-Ride.....	28

TRANSIT DEVELOPMENT DESIGN GUIDELINES

Introduction

The Votran Transit Development Design Guidelines (TDDG) provide the transit design standards and processes used to construct the transit infrastructure needed in the built environment. This guide has been developed to be used in coordination with the River to Sea Transportation Planning Organization's Transportation Impact Analysis (TIA) guidelines process with emphasis given to the transit corridors within the existing and planned Votran service area. This guide is also appropriate for anyone interested in improving the transit-friendliness of their designs. Votran encourages local planning or public works departments to become familiar with this document, and when possible, to appoint a regular 'liaison' or staff contact to be responsible for representing the interests of transit in the development review process. There is no financial commitment for improvements by Votran based on the information provided in this document.

Developers should initially contact the City/County Transportation Engineer (CTE) for transit provisions prior to contacting Votran. The CTE during the TIA methodology review should establish the transit analysis requirements for the development's TIA submittal. The CTE should review the transit component of the submittal and where appropriate incorporate the TDDG into the development order. However, if contacting Votran is directed by the CTE at some point through the TIA or facility design process, developers should submit their site plan along with any questions via email for Votran review. Prior to submitting the design for any facility in Volusia County, the developer should confirm that the transportation portion of the TIA has been completed and approved consistent with the CTE/applicant facility methodology meeting. The TIA process flow chart is presented as Appendix E for review.

The guidelines included in this document are intended to provide general parameters for personnel and organizations when integrating transit design into developments. This document is not intended to be an engineering design manual, and it does not provide site-specific detailed public transit, engineering, architectural, construction, or legal information. Users of this document will need to adjust the information contained in the guidelines to site-specific needs, constraints, and applicable laws, regulations, and ordinances. If a user desires expert advice concerning any of the information in these guidelines, the user is encouraged to retain the services of an appropriate expert.

How to Use these Guidelines

These guidelines should be used by private and public sector developers and their project planners, engineers, and architects when planning or designing any development or redevelopment project. They should also be used by local government staffers as they review private sector project proposals for approval and when they plan and design public sector improvements (e.g., roads, government offices, libraries, schools, parks and recreation facilities and other community facilities).

It is generally appropriate to apply these principles related to transit vehicle circulation and transit accessibility; and it is particularly important to do so when transit service is available or is expected to be available.

Developers, Project Planners, Engineers, and Architects

One of the earliest considerations, even before preparing a conceptual design, should be whether the proposed development is located within an existing or future transit service area. If transit service is available at the site, or will be available in the foreseeable future, the fundamental elements of the development including type of use, density or intensity, and form can usually be tailored to better support transit service and to reap greater benefits from the availability of transit service.

Votran will not normally review a development proposal or plan; however, if the proposed development is deemed to be “significant” with respect to its impact on transit service the CTE is encouraged to contact Votran and may at their discretion request Votran’s involvement in the review process at a very early stage.

Votran encourages developers to consider these guidelines carefully, and to incorporate the transit design features into every project.

Local Government Planners, Engineers, Planning Boards and Elected Officials

The needs of transit service providers and users, pedestrians and bicyclists should be routinely considered in the review of every development proposal just as automobile access and parking, landscaping, and utilities are now considered.

If a development is proposed in an area where transit service exists or is anticipated, it should be designed to integrate and support it, not just accommodate it. For that, it is necessary for transit-friendly design principles to be reflected in the basic elements of a development.

Local government planners, engineers, planning board members and governing board members should be well acquainted with the principles of transit-friendly design described in this document so that they will better recognize at an early stage whether a development proposal does appropriately integrate and support transit service. It is best to raise transit service considerations at the conceptual plan review stage or earlier, before a developer has expended time and money on design and engineering.

Incorporate the Principles into Plans and Regulations

Many local governments in Volusia County have included in their comprehensive plans, goals, objectives and policies which support compact development and multi-modal transportation systems. However, successful implementation will require a degree of integration between land use and transportation planning that may not be evident in those plans. Local governments should review their plans to see if they can be amended to promote closer integration. Recommended throughout this document are design standards that should be incorporated into binding local government codes to achieve communities that support mobility options.

Local governments are encouraged to review their land development codes to incorporate transit-supportive design principles as appropriate. Some principles can be adequately addressed by inclusion of specific language, while others may require much broader consideration of the codes and how seemingly unrelated provisions can impact transit service and accessibility to transit. By incorporating these guidelines into land development codes, consideration of transit will be “institutionalized” and developers will be better informed of the local government’s expectations.

If the CTE has training in the transit service field, addressing transit accessibility is less of an obstacle; however, CTEs that are not wholly comfortable with determining transit infrastructure needs are encouraged to coordinate with Votran or the River to Sea Transportation Planning Organization staff (or both) for assistance with the development review.

Transit Corridors

Future improvements should be focused within the existing Votran service area. Development and redevelopment occurring along the most heavily-traveled corridors in the county that have existing fixed-route bus service and higher ridership levels are candidates for premium transit service, easy-to-recognize stops and stations, and increased frequency of service. Therefore, design is of great importance for those geographic areas located within and surrounding the transit corridors. While Votran may incorporate additional corridors in the future, the existing transit emphasis corridors are listed below. Design standards that should be incorporated along these corridors are described in detail in the next section of this guide.

- US 17/92
- International Speedway Boulevard
- A1A
- US 1
- SR 40

It is also important to note that the cost of any transit access to development projects provided by Votran and located outside of the existing Votran service area will require the full funding amount from the developer or another mechanism determined through coordination with Volusia County. Based on Votran’s current funding levels and budget, funding is not available for new service. It is also important to note that any expense related to a request for the removal or relocation of an existing bus stop will also be absorbed by the requestor. This document will be updated as appropriate to evolving conditions such as: transit levels, legislation, design standards, and development needs.

Thresholds for Review

One of the earliest considerations, even before preparing a conceptual design, should be whether the proposed development is located within an existing or future transit service area. The most current Votran system map can be located at <http://www.votran.org/take-a-trip/maps-schedules.shtml>. If transit service is available at the site, or will be available in the foreseeable future, the fundamental elements of the development including type of use, density or intensity, and form can usually be tailored to better support transit service and to reap greater benefits from the availability of transit service.

Table 1 can be used as an aid for plan review to ensure that all principles are given due consideration. If the proposed development is within the existing transit service area and meets the thresholds shown in Table 1, please refer to the design standards and prototypes in the next section and within the appendices for direction on transit-friendly designs.

Regulatory Requirements for Inclusion

The TIA provides information on the projected traffic expected from a proposed development and evaluates the impact of the proposed development at full buildout on the multimodal transportation system, including roads, transit, bicycle, and pedestrian facilities. If the TIA determines that the Level of Service (LOS) of the impacted roadway(s) is deficient, potential mitigation strategies and improvements to the transportation system will be required, in accordance with the local government comprehensive

plan. The TIA should also identify and address impacts to multi-modal components (transit, bike, and pedestrian) of the transportation system and provide mitigation, as appropriate, for deficiencies.

The TDDG provides transit-oriented recommendations for addressing impacts to multi-modal components of the transportation system that are identified through the TIA process. Similar to the TIA guidelines, when using these guidelines, the review and requirements shall be in accordance with the applicable section of the City/County Zoning Ordinance or Land Development Code (LDC). A listing of applicable transit supportive LDC by jurisdiction has been included as Appendix C to ease the review process; however, the applicant is encouraged to review the zoning ordinances and LDC for the geographic area where the proposed project is located to ensure that the most current codes are reviewed. While not considered a regulatory requirement, the best practice for the construction and placement of some transit facilities should not only coordinate with the local jurisdiction issuing the permit, but also coordination with the Florida Department of Transportation (FDOT) local operations center, including the District Americans with Disabilities Act (ADA) coordinator for ADA-related issues.

Design Standards

The following section contains design prototypes based on requirements in state or federal law or rules from industry best practices. The design standards included in this document are referenced from the Florida Department of Transportation's Accessing Transit: Design Handbook for Florida Bus Passenger Facilities, Version III. Pertinent standards that are applicable to Volusia County were identified and documented in this guide for quick access. To assist in the design process, the remainder of this section includes an overview of the design elements for the facilities, pedestrian connections, and amenities included in Table 1.

This guide recommends that all new developments be designed to accommodate up to 35 foot buses to ensure the best possible transit service. The vehicle specifications for a standard Votran 35 foot bus and the turning radius for a 40 foot bus are shown in Figure 1. The turning radius for the 35 foot bus would be 36' rather than the 42' shown in the figure. However, the angle of an intersection, the number and width of roadway lanes, and vehicle operating speeds greater than 10 mph may require additional turning radii as well as the addition of bicycle racks on the front of buses and should be considered in design construction standards. A bus with a front-mounted bicycle rack typically requires at least 1.5 additional feet added to the turning radii. This may vary by bus and rack manufacturer. This guide also includes a brief discussion on Crime Prevention through Environmental Design (CPTED) standards that are recommended for incorporation into all development/redevelopments as good practice.

Figure 1: Standard 40-Foot Bus Turning Radius

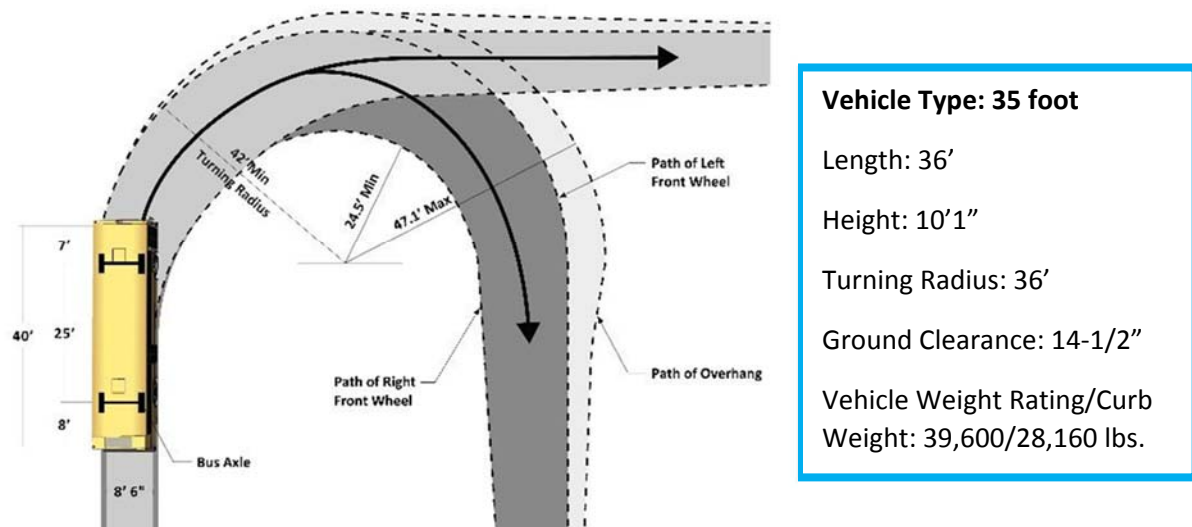

Source: Votran and FDOT Accessing Transit, June 2013

Consistent with the Accessing Transit handbook, this guide does not address the complex process of design, architectural programming, and transit planning necessary for construction but rather provides examples of best practices. Design standards will vary by project depending on the geographic location of the development/redevelopment project and other environmental factors. Appendix D presents more detailed information on design standards for the certain transit infrastructure designs outlined in this document. Votran’s typical fixed-route bus is 35 foot, although this is subject to change in the future.

Table 1: Transit Infrastructure Recommendations

Step I: Select Development Type (Review TIA Guidelines for potential transit requirements)	Transit Infrastructure Recommendations by Type of Development	General Development Type by Density/Intensity					Transit Oriented Development (TOD)		Traditional Neighborhood Development (TND)		Mixed Use Trip Reduction Measures (MUTRM) Area		
		2 DUs/Acre OR Residential Development of 50-100 DUs	3-4 DUs/Acre OR Residential Development of 101-250 DUs	5-6 DUs/Acre OR Residential Development of 251-500 DUs	7-10 DUs/Acre OR Residential Development of 501-1000 DUs	> 10 DUs/Acre OR Residential Development of > 1000 DUs	Transit Neighborhood (0.25 - 0.50 miles from the center of TOD)	Transit Core (0 - 0.25 miles from the center of TOD)	Neighborhood Center	Town/Village Center	Non-Compact Development Area (Non-CDA)	Compact Development Area (CDA)	
		10K-30K SF of Non-Residential or Mixed Use Developments	31K-50K SF of Non-Residential or Mixed Use Developments	51K-200K SF of Non-Residential or Mixed Use Developments	201K-600K SF of Non-Residential or Mixed Use Developments	> 600K SF of Non-Residential or Mixed Use Developments							
Step II: Review Transit Plans ^{1,2}	10-Year Funded TDP (Build if service is funded within 5 years. Meet with to determine applicable infrastructure for services funded for later than 5 years.)												
	L RTP Cost Affordable Transit Plan (Build if service is funded within 5 years. Meet with to determine applicable infrastructure for services funded for later than 5 years.)												
Step III: Identify Infrastructure Requirements for Each Planned Service Type in TDP and/or L RTP (local/express/BRT) & Coordinate with County/City Staff to Provide Required Infrastructure ^{3,6}	Bus Bay/Pull Out	■	■	■	■	■	■	■	■	■	■	■	■
	Bulb-Outs						■	■	■	■	■	■	■
	Bus Shelter Easement	■	■	■	■	■	■	■	■	■	■	■	■
	Sidewalk Connectivity (Paved Walkway)	■	■	■	■	■	■	■	■	■	■	■	■
	Bike Lane Access		■	■	■	■	■	■	■	■	■	■	■
	Bus Stop Landscaping						■	■	■	■	■	■	■
	Park-n-Ride Connectivity (Paved Walkway)		■	■	■	■	■	■	■	■	■	■	■
	Bus Stop Sign & Pole	■	■	■	■	■	■	■	■	■	■	■	■
	B&A Area Concrete Pad	■	■	■	■	■	■	■	■	■	■	■	■
	Bench	■	■	■	■	■	■	■	■	■	■	■	■
	Shelter (See Table 2 and 3 for type/size) ⁴		■	■	■	■	■	■	■	■	■	■	■
	Major Transit Station	Provide in Transit Center Overlay Areas and any other areas as specified by County/City. See Comprehensive Plans or L RTP for Transit Overlay locations, density/intensity, and station types.											
	Park-n-Ride	Provide at applicable locations identified in the 2040 L RTP. Scale, timing, and site requirements should be based on discussions with County/City staff and Transit Design Manual.											
	Map/Schedule Display	■	■	■	■	■	■	■	■	■	■	■	■
	Lighting		■	■	■	■	■	■	■	■	■	■	■
	Bike Storage	■	■	■	■	■	■	■	■	■	■	■	■
	Trash Receptacle	■	■	■	■	■	■	■	■	■	■	■	■
Off-Board Ticket Vending Machines ⁷		■	■	■	■	■	■	■	■	■	■	■	
Public Art							■	■	■	■	■	■	

Notes:

- If bus transit services, including local, express, or BRT services in TDP or L RTP are funded within 5 years of the date of development approval, provide recommended infrastructure.
- If bus transit services in TDP or L RTP are funded after 5 years from the date of development approval, meet with County/City staff to determine applicable infrastructure that should be provided. These may include, but not limited to bus bays/pull outs, bulb-outs, bus shelter easements, sidewalk or/and park-n-ride connectivity (paved walkway).
- These recommendations apply to existing & proposed developments meeting the following criteria:
 - The existing or planned transit service route shown in the funded TDP or L RTP is wholly or partially within the development.
 - The development abuts a roadway corridor with an existing or planned transit route shown in the funded TDP or L RTP.
- Intermediate and large bus shelter sizes may vary based on ROW availability and daily boardings.
- Use Table A - Average Bus Stop Spacing by Mode as a guide to determining the required number of bus stops. Final determination of the number and location will be made by County/City staff.
- Facilities identified here must be constructed in accordance with the Transit Design Manual and Americans with Disabilities Act (ADA) Standards.
- Off-board ticket vending machines are for BRT/Rail only.

Table A: Average Bus Stop Spacing by Mode⁵

Facility/ Type	Bus Stop Spacing (miles)						
	Rural	Suburban	Urban	TOD	TND	MUTRM Area	Activity Center*
Local Bus Stop	3/4 - 1/2	3/4 - 1/4	1/4	1/4 - 1/8	1/4 - 1/8	1/4 - 1/8	At or adjacent
Express Bus Stop	Varies. See TDP/L RTP and Development Services/ staff.						to major
BRT Station	Varies. See TDP/L RTP and Development Services/ staff.						activity centers.

*As determined by County/City staff. Major activity centers may include regional malls, airports, hospitals, colleges, big box retailers, large recreational facilities, etc.

Crime Prevention Through Environmental Design

CPTED is an approach to deter criminal activity by designing safety and security into the infrastructure. The use of CPTED principles in the site plan will help to provide natural surveillance for the transit user and the property owner. Votran considers CPTED an important practice and has included in this guide some of the basic strategies for transit stations and stops that are recommended by the American Public Transportation Association (APTA). These design standards have been included for review and incorporation into site plans, as appropriate. Some of the principles listed may not be applicable to the development depending on the local jurisdiction land development regulations within the jurisdiction where development is occurring. Figure 17 presented in the Bus Stop Landscaping, Lighting, and Trash Receptacle section of this document presents an example of appropriate landscaping at a typical bus stop in accordance with CPTED principles.

Table 2: Crime Prevention Through Environmental Design Standards

Strategy	Standard
Stations and Terminals	<ul style="list-style-type: none"> • Sight lines should not be obstructed by information centers, ticket vending machines, concessions, and ads • Install mirrors on blind corners • Use transparent materials to enhance sight lines and security • Where possible, stations/terminals should have open shafts or skylights to bring in natural light • Off hour waiting areas should be clearly marked, visible to customers, and equipped with CCTV and intercom systems • Instructions should be posted or broadcasted explaining how to report suspicious activity • Bright colors should be used to increase ambient lighting • Hidden areas or remote passageways should be minimized • Columns and blind corners should be minimized • Sufficient lighting should be provided for nighttime surveillance
Transit Stops	<ul style="list-style-type: none"> • Physical barriers such as bollards and fencing should be provided for protection from ramming, or to prevent unauthorized access if the stop has a segregated transit way • Sight lines should not be obstructed by information centers, ticket vending machines, concessions, and ads • Signage should be provided to deter non-transit vehicles from the stop area • Emergency call boxes are provided to report incidents • Adequate lighting is provided for surveillance

Source: American Public Transportation Association, Crime Prevention Through Environmental Design (CPTED) for Transit Facilities, June 24, 2010.

Bus Stop Sign & Pole

Design Standards & Facts

Bus stop signs provide references for bus passengers and bus operators. Votran designates bus stops based on needs of the public, the route availability of the transit system, and sites with the greatest ADA accessibility. Votran's bus stops are usually located on the street (curb-side). Development projects should be designed to accommodate pedestrian traffic between bus stops and building entrances. Therefore, buildings should be located near the street or provide short, direct access between building entrances and bus stops. Votran selects either near side, far side, or mid-block locations for the stops based on the easiest accessibility and minimizing conflicts between buses and other vehicles leaving or entering driveways. Some of the key elements that should be considered when placing bus stop signs are listed below. See Appendix A for more detailed information on Votran's Technical Design Standards for Accessible Bus Stops.

- Bus stop signs must be posted at all bus stops and bus passenger facilities and should include the route or routes available from that bus stop.
- Signs shall provide a minimum of 7' vertical clearance from the paved service (sidewalk or roadway pavement). If the vertical clearance is less than 7' and is placed along an accessible route, a barrier to warn people with visual impairment should be provided.
- The sign and post placement must conform to the ADA as well as Florida-specific requirements for height, width, visibility, and other design and location criteria.
- The sign must be securely mounted at an angle perpendicular to the street. Signs shall be attached to supports meeting the location, height, and lateral placement requirements established in FDOT Design Standards, Index 17302.
- Bus stop signs must comply with the most stringent requirements included in the Manual on Uniform Traffic Control Devices (MUTCD).
- The bus stop sign must neither block jurisdictional signs nor be blocked by other signs, trees, or buildings.
- Bus route identification signs must comply with the viewing distances presented in Appendix D.

Figures 2 and 3 illustrate examples of Votran's bus stop sign and poles at various locations. Figures 4 through 7 present examples of bus stop sign dimensions based on the locations.

Figure 2: Votran Bus Stop Sign on Existing Pole



Figure 3: Votran Bus Stop Sign and Pole



Figure 4: Bus Stop Sign on Far Side of Sidewalk

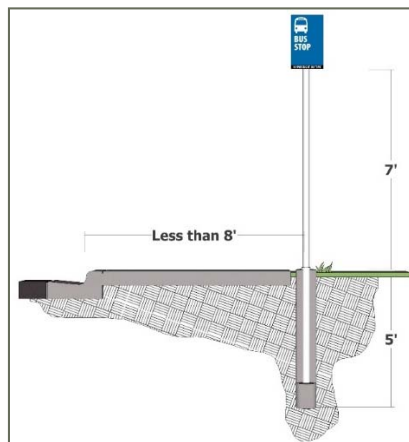

Figure 5: Bus Stop Sign in Planting Strip

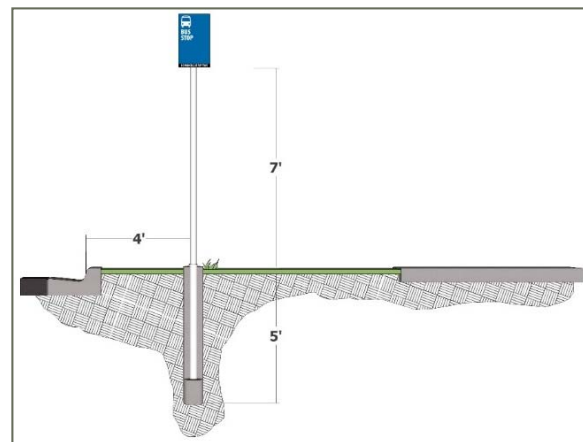

Figure 6: Bus Stop Sign on Near Side of Sidewalk

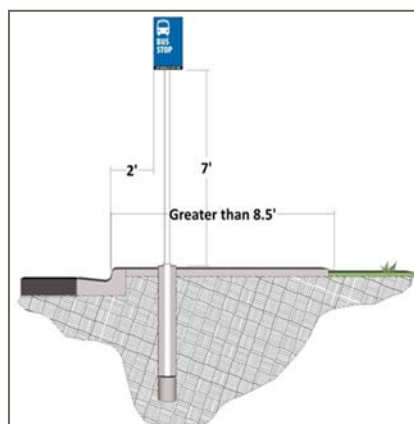
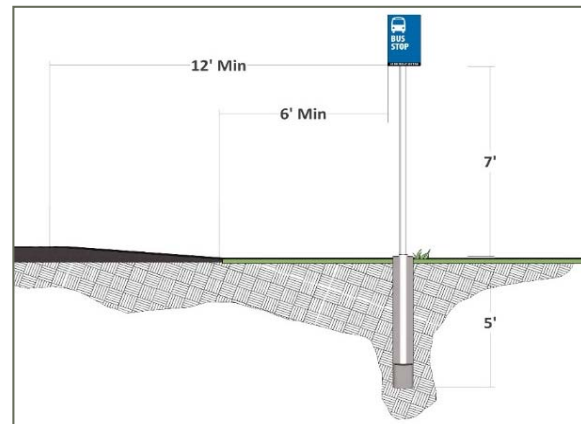

Figure 7: Bus Stop Sign (No Sidewalk, Curb or Gutter)



Source: Accessing Transit: Design Handbook for Florida Bus Passenger Facilities, Version III, 2013

Positives

- Convenient access for transit users thereby enhancing pedestrian safety. This may positively impact the need for paratransit access to the site.
- In accordance with the FDOT Complete Streets Policy, streets should serve the transportation needs of transportation system users of all ages and abilities, including but not limited to cyclists, motorists, pedestrians, and transit users. Complete Streets are streets that are well designed for transit can encourage more people to get out of their cars and onto the bus. Such streets provide accessible bus stops and assist buses in moving through traffic. Therefore, bus stops allow for alternative modes of access along the roadway.
- Reduces pedestrian conflicts.

Negatives

- May lead to additional amenity requirements such as trash receptacles, lighting, and future shelters based on usage at the stop locations.

Boarding & Alighting Area

Design Standards & Facts

The minimum requirements for a bus stop include a bus stop sign and a Board and Alighting (B&A) area. Based on ADA requirements, the B&A Area should be a firm, stable surface with a minimum clearance length of 8' and a minimum width of 5' (measured parallel to the roadway). This area should be connected to streets, sidewalks, or pedestrian pathways. The basic requirements for a B&A area are listed below.

- A sidewalk and/or ramp provided with the B&A area shall be a minimum of 60 inches in width and the ramp shall not exceed a slope of 1:12 (8.33%).
- Detectable warning surface is required where a sidewalk associated with a B&A area connects to the roadway at grade. Except for the area adjacent to the 5-inch curb, the areas surrounding the B&A area shall be flush with the adjacent shoulder and side slopes and designed to be traversable by errant vehicles.
- A B&A area is still required, but it may not have to be a concrete pad when bus stops are designated by only a sign on a post and no other amenities (shelters, benches, trash cans, etc.) are located at the stop and complementary ADA paratransit service is provided. If a concrete pad is provided, the concrete pad must be located within the specified clear zone for the roadway environment being used according to FDOT Design Standards, Index 700.
- If a concrete B&A area is constructed, requirements include 6-inch-thick concrete on flush shoulder roadways owned by the State. Bus stop B&A areas should be constructed of reinforced concrete over an aggregate base or they may be made of recycled plastic or rubber aggregate.
- The B&A area should not be obstructed by any physical features (poles, stop amenities, advertising displays, etc.)
- Accessing paths to bus stop B&A areas must be designed to maintain a minimum clearance width of 36 inches (48 inches per FAC, 60 inches per PPM) and vertical clearance of 80 inches.
- Additional details on the accessibility and design of B&A areas, refer to the most recent versions of ADA Standards, PPM, 2012 Florida Accessibility Code, and draft Public Rights-of-Way Accessibility Guidelines (PROWAG).

Figures 8 through 10 are examples of B&A areas based on the design standards included in the FDOT Accessing Transit Handbook. Figure 11 illustrates an existing Votran bus stop and B&A area without a shelter or bench.

Figure 8: B&A with an adjacent bench

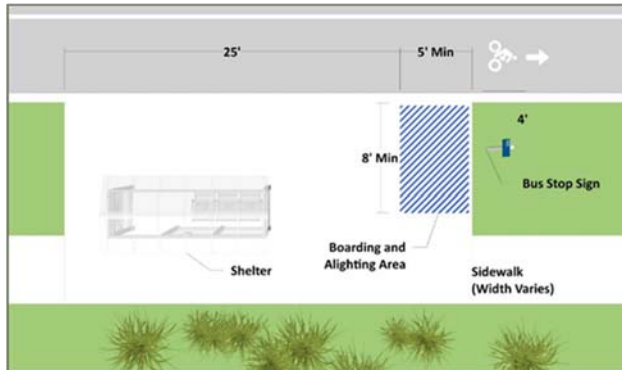

Figure 9: B&A area without a shelter or bench

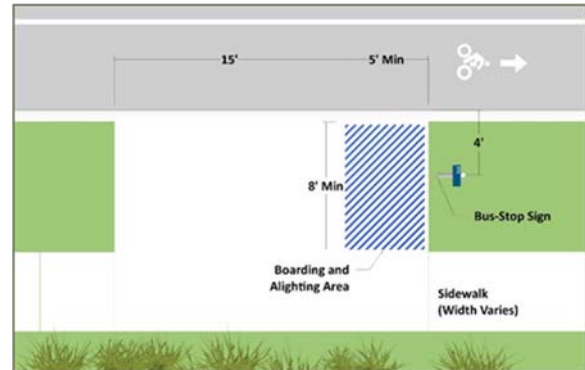
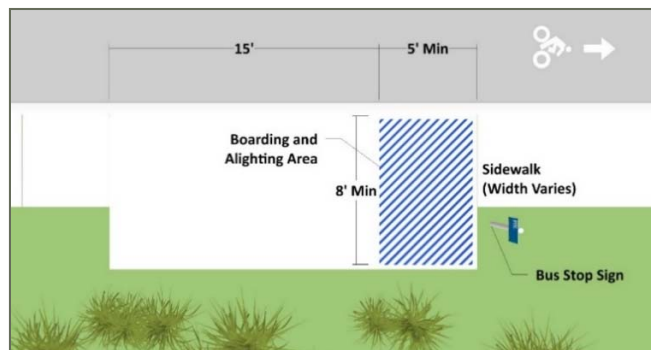

Figure 10: B&A Configuration (Sidewalk Adjacent to Curb) Figure 11: Votran B&A area



Positives

- Safer passenger access to transit.
- Compliance with ADA regulations.
- Improved pedestrian access to facilities.

Negatives

- Cost of B&A area if pad is constructed or amenities are added.
- There may be costs associated with maintaining pad.

Bus Stop Shelters & Easements

Design Standards & Facts

Shelters protect waiting passengers from exposure to the sun and rain. The minimal form of a shelter is an overhead canopy beneath which passengers wait for the bus. Optional side enclosures for shelters and the provision of other amenities under, or near, the shelter enhance the image of the transit service and offer a comfortable and convenient transit trip for patrons. In Florida, it is of particular importance to design with the climate in mind. Solar radiation, heavy precipitation, and high relative humidity make waiting for the bus, especially in summer, extremely uncomfortable for passengers. As a result, allowing for shading, shelter, and ventilation are important considerations. Also, the typical angle of falling rain in Florida is 30 degrees and the approximate angle of late p.m. peak sun in midsummer is 41 degrees (for a SW facing shelter); therefore, shelter designs should incorporate features that reduce the effects of those elements.

Shelter designs must comply with Florida Building Codes, FDOT Accessing Transit guidelines, and local codes, which may be stricter. Shelter locations must also meet setback and minimum clear recovery zone requirements as established in the FDOT Design Standards, Index 700. Some of the general requirements for shelters are listed below.

- Per FAC 14-20.003, a shelter may be erected only at bus stops designated by a public transit agency or the local school board, and identified as having service a minimum number of 10 times in a 5-day period, excluding weekends and holidays.
- Per FAC 14-20.003, the maximum height of a shelter cannot exceed 10 feet for shelters located on the State Highway System.
- Shelters should be on the public access route, but should not block the public access route.
- Shelters should have a minimum clearance of 48 inches, but a recommended 60 inch clearance.
- Shelters should have a 30"x48" minimum clear floor area to accommodate wheelchairs.
- Shelters should have a 48" minimum approach to clear floor area.
- Shelters shall not be placed on sidewalks where they could obstruct the movement of pedestrians.
- When a shelter is located on the street side of a sidewalk, a minimum 4' pedestrian pathway, per State requirements, shall be maintained on three sides of the shelter. In areas with high pedestrian volumes, a 6' pathway on one side of the shelter is preferred.
- To meet ADA Standards, the sidewalk adjacent or connected to the shelter must be designed with a width of at least 5 feet or, at every 200', a space at least 5'x5' must be provided so that two wheelchair users can pass traveling in opposite directions.
- The ADA B&A area can be extended into the clear space within the shelter (no obstructions to 5'x8' area allowed).
- Shelters should be located at least 15' away from a fire hydrant or a parking space for the disabled and at least 7' from a utility pole.
- Shelter access entry and exit points must provide a minimum clear width of 4'.
- There shall be no vertical change in elevation greater than ¼-inch untreated or ½-inch treated to a slope of 1:2 along the walking surfaces between the sidewalk or bus B&A area and the shelter.

Changes in level greater than ½-inch must be ramped in compliance with 405 and 406 of the ADA Standards.

- Shelters close to the road should incorporate breakaway mechanisms in order to be frangible or breakaway. Breakaway mechanisms include slip-bases and bases incorporating a component with low impact strength.
- Prior to the installation of a shelter, the impacted utility companies must be notified to determine the location of utilities.
- To allow clear passage of the bus and its side mirror, shelters should be a minimum distance of 5’ between the face of the curb and the roof or panels of the shelter.
- When placing a bus shelter, the open side of the shelter should be placed toward the street and should be grade-separated from the travel lane.
- Shelters are not required to have seating but it is a best practice to include seating space for three adults and one space for a wheelchair (30 inches by 48 inches minimum).
- Space should be allowed behind the shelter for maintenance (typically a clear minimum area of 2’ and 12” minimum when shelter is located against a building or structure)
- Shelters should be connected to adjacent access pathways, including sidewalks and shared use paths.
- Shelter design must consider uplift, exterior wind pressures, and shatter resistance materials per the Florida Building Code. Also, shelters should be appropriately anchored.
- Cameras, if deemed appropriate for the site, should be installed inside and outside the shelter to monitor activities and CPTED principles should be incorporated to enhance natural surveillance.
- Per FAC, shelter sides and internal dividers shall be constructed in a manner to provide visibility of waiting passengers to passing traffic and pedestrians.
- All transparent materials must be shatterproof. No shelter shall be located in such manner or be constructed of such materials so as to adversely affect sight distances at any intersection or obstruct the view of traffic signs or other traffic control devices. If used, glass panels should be marked with a distinctive pattern or by using contrasting colors to indicate their presence. It is better to have no advertising panels on a shelter at all to avoid limited visibility.

The decision to place a bus shelter should be based on a number of factors, including ridership, location, and route connectivity. Table 3 presents the minimum boardings suggested by location for considering a bus shelter. Table 4 presents the preferred locations by shelter type. Figures 12 and 13 present examples of shelter dimensions.

Table 3: Minimum Boardings Suggested by Location for Considering Bus Shelters

Location	Minimum Boardings
Rural	10 or more per day
Suburban	25 or more per day
Urban	50 to 100 per day

Source: Accessing Transit: Design Handbook for Florida Bus Passenger Facilities, Version III, 2013

Table 4: Preferred Locations by Shelter Type

Shelter Type	Threshold - Urban (Minimum Daily Boardings)	Preferred Location
Basic shelter (8.5'X4.5'X8')	50	Business and retail districts, residential neighborhoods, industrial and manufacturing areas, etc.
Narrow version of basic shelter (8.5'X2.5'X8')	50	Pursued when a basic and most common shelter is warranted but right-of-way is limited
Longer version of basic shelter (12'X4.5'X8')	100	At stops with strong usage
Longer version of narrow shelter (12'X2.5'X8')	100	All stops with strong usage and limited setback
Large shelter (16'x4.5'X8')	150	At stops with significant ridership and likely only at activity centers
High-capacity shelter (size varies)	>200	Special shelters for extremely high usage areas (e.g., transit centers and high transfer points)

Source: Accessing Transit: Design Handbook for Florida Bus Passenger Facilities, Version III, 2013

Figure 12: Example of Small Bus Shelter

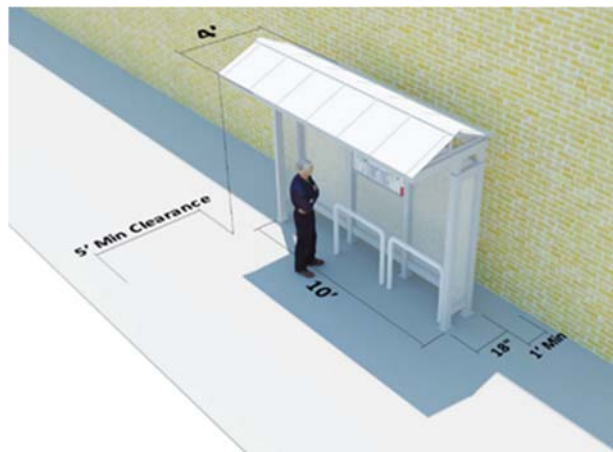
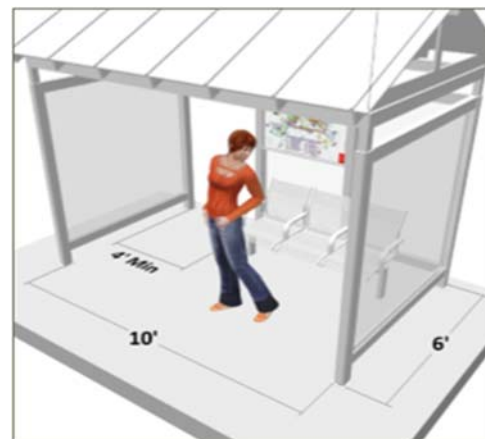

Figure 13: Example of Mid-Sized Bus Shelter



Source: Accessing Transit: Design Handbook for Florida Bus Passenger Facilities, Version III, 2013

The provision of a bus shelter easement will allow Votran to use private property to establish a bus stop shelter. An easement could be requested for a development with anticipated future or existing transit usage. This would also allow the system to expand in the future, when proposed routes are programmed in planning documents or increased frequencies are expected along major corridors. As a result, the county and the land owner may enter into an agreement for the dedication of land to construct bus shelters and provide the county with a fully executed grant of easement. This agreement may also include

financing of the shelter on the real property to be dedicated as part of the landscape corridor or public right-of-way. See Appendix B for a sample joint use agreement.

The county, on behalf of Votran, may sign an agreement with the owners of private property on which it would like to locate a stop, allowing the agency to locate the bus stop in the most accessible location for pedestrians.

Positives

- Use of property that improves experience for transit passengers by providing safe, well lit, waiting areas.
- Provides weather protection for customers that use transit.
- Can provide opportunity for additional advertising, provided sufficient passenger visibility can be ensured, and based on local government ordinances.
- Improves likelihood of continued or future transit service to locations due to the infrastructure investments.

Negatives

- May attract persons not using transit to the sheltered location because of weather protection and possible seating.
- Cost of transit shelter improvement and associated maintenance.

Benches & Bike Storage

Design Standards & Facts

The installation of bus benches should be coordinated with the local government responsible for the location and permitting approvals, ADA requirements, and maintenance. Typically, 4' benches are placed inside shelters, 6' benches are used for ad exposure, and 6'2" premium benches are placed in areas with a minimum of 25 daily boardings and near business and retail districts without shelters. The general requirements for benches that have been provided in the FDOT Accessing Transit guidelines are listed below.

- Benches should be located on accessible routes, but not blocking accessibility to the route.
- A 30"x48" concrete pad should be provided located adjacent to the bench.
- Benches must not obstruct the full 5'x8' B&A area or passenger access to loading and unloading areas.
- Clear floor ground or ground space 30 inches by 48 inches minimum with slopes not steeper than (2.08%) shall be provided and shall be positioned at the end of the bench seat and parallel to the short axis of the bench.
- Benches must be able to support 250 pounds of force applied at any point on the seat, fastener, mounting device, or supporting structure.
- If provided, grab bars cannot obstruct transfer to the bench. Grab bars and arm rests can be used as tools to help keep people from laying down on the bench.
- At least 50 percent of benches, but no less than one, at each location should provide clear space adjacent to the bench.
- Benches should not be placed closer than 1 foot from the edge of a sidewalk or 4 feet from the edge of a shared path.
- Bench locations must meet the setback and minimum clear recovery zone requirements as established in FDOT Design Standards, Index 700.

Figure 14 present typical bus bench dimensions and Figure 15 illustrates benches located at Votran's Market Place transfer location.

Figure 14: Typical Bus Bench Dimensions

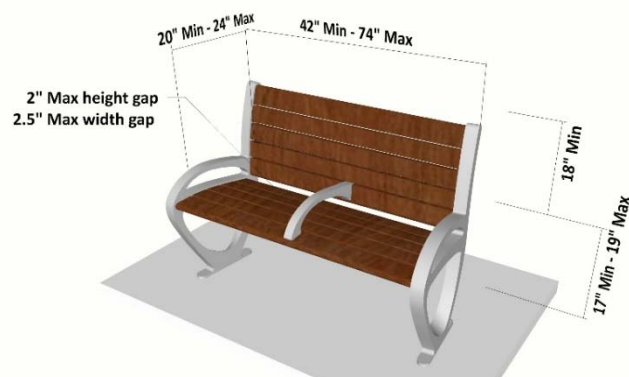

Figure 15: Bus Benches at Votran Transfer Point



Source: Accessing Transit: Design Handbook for Florida Bus Passenger Facilities, Version III, 2013

Bicycle storage is an important component for passengers that use bicycles to complete the first mile and last mile of their transit trip. Therefore, bicycle racks should be placed at bus stops and along routes with bicycle accessibility. Racks can also help when bus-mounted bike racks are at capacity allowing the passenger to leave the bike behind and still board the bus. Key design elements for bike racks from FDOT’s Accessing Transit guidelines are below. Figure 16 presents the appropriate dimensions for inverted “U” bike racks.

- Bike racks should be placed in areas with high visibility, but underneath a covered area, where possible.
- Bike racks should not be placed on or block the B&A area.
- Bike rack locations must meet the setback and minimum clear recovery zone requirements established in FDOT Design Standards, Index 700.
- The height of bicycle racks should not exceed 4 feet from the paved surface.
- Bicycle racks should provide 48-inch aisles, measured from tip to tip of bicycle tires across the space between racks or between the tip of the tire and an adjacent obstacle.
- A total of 72 inches of depth should be allowed for each row of parked bicycles.

Figure 16: Bicycle Rack Dimensions (Inverted “U” Bicycle Racks)

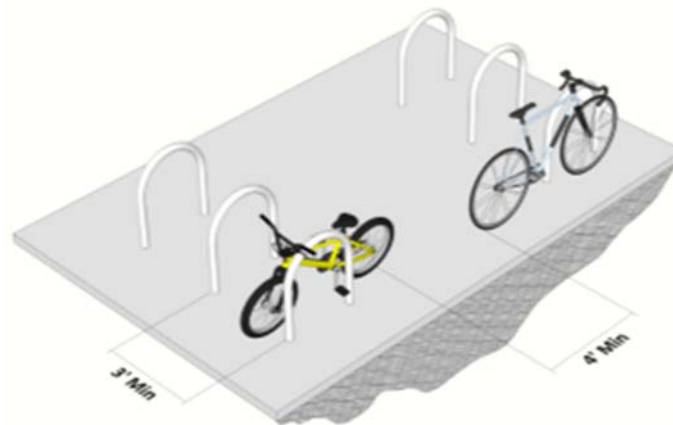

Source: Accessing Transit: Design Handbook for Florida Bus Passenger Facilities, Version III, 2013

Positives

- Bicycle racks are beneficial in rural areas where the distance to access the transit stop is greater.
- Parking space considerations may be provided by the local jurisdiction based on bicycle facilities.
- Seating locations can reduce patrons standing or blocking entry and exit ways.
- Benches can provide, in accordance with local regulations, an additional area for the promotion of uses.
- Improved amenities for bus passengers may increase patronage.

Negatives

- Cost of improvements.
- Dealing with potential incidences of bicycle thefts.

Bus Stop Landscaping, Lighting, and Trash Receptacles

Design Standards & Facts

Landscaping along FDOT rights-of-way must comply with standards in the latest editions of the Plans Preparation Manual (PPM), Florida Highway Landscape Guide, and the FDOT Design Standards Index 546 and Index 700. At a minimum, trees should allow 9' 10" of vertical clearance from sidewalks or B&A areas. The height of ground cover plants should not exceed 2' and the height of shrubs should not exceed 3' at maturity for visibility purposes. To reduce the required maintenance and irrigation of plant materials, native plants and wildflowers should be used.

All landscape installation should be coordinated with the state or local agency responsible for maintenance. Landscaping should also be installed consistent with CPTED principles for safety and security purposes. Figure 17 presents an example of appropriate landscaping at a typical bus stop.

Figure 17: Example of Bus Stop Landscaping

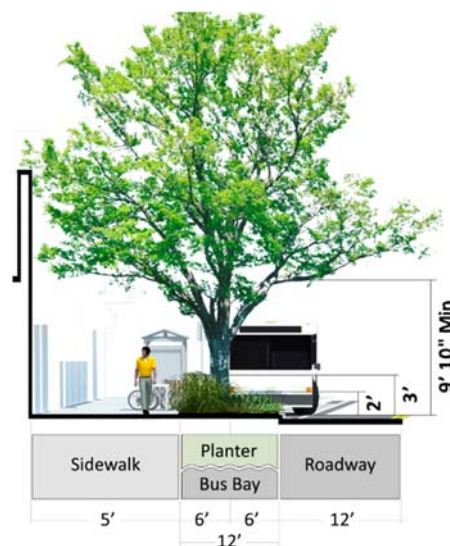

Source: Accessing Transit: Design Handbook for Florida Bus Passenger Facilities, Version III, 2013

Lighting is the most important safety and security feature for waiting passengers and can be effectively accomplished through the use of CPTED practices. In order to reduce light pollution, lighting should be designed to eliminate light trespass from the bus passenger facility, improving night sky access, and reducing nuisance glare on adjacent properties and within the roadway.

- As a best practice, local stops should be placed within 30' of an overhead light source, if no shelter is included. If a shelter is provided, a minimum of 15' is the recommended distance between the shelter and the nearest light pole.
- Pedestrian scale lighting is desirable for major transit corridors to make the environment more safe and inviting for pedestrians. However, lighting should not cast shadows on the passenger waiting area.
- All shelter utility connections shall comply with Rule 14-46.001, FAC, and must be approved by the appropriate city or county building department.

- Lights within a shelter must be placed or shielded so they do not interfere with motorists on roadways, but rather illuminate passengers. The level of lighting at the shelter pavement should be between 22 and 54 lumens per square meter. Flashing lights on shelters are prohibited.
- A minimum 7-foot vertical clearance from the paved surface should be maintained under all conditions for lighting fixtures outside of the shelter.
- Fixtures should be vandal resistant and durable.

Trash receptacles can be placed at stops and shelters to allow for disposal of unwanted items and maintain the appearance of the area. The design of trash receptacles should be coordinated with the appropriate agencies to ensure that local and state codes are met and the receptacles are compliant with ADA regulations. Prior to installing trash receptacles, the appropriate agency should be identified for maintenance and pickup. Based on the FDOT Accessing Transit guidelines, requirements for the provision of trash receptacle at bus stop locations are listed below. Figure 18 illustrates the appropriate spacing for trash receptacle placement at bus stop locations.

- Trash receptacle locations must meet the setback and minimum clear recovery zone requirements established in FDOT Design Standards, Index 700.
- Trash receptacles should not be placed on bus stop B&A areas.
- Trash receptacles should be at least 4 feet back from the face of the curb and should be anchored to the pavement or B&A area to prevent unauthorized movement.
- Placement of trash receptacles should not obstruct a driver’s vision while turning or impede pedestrian circulation in and around transit stops.

Figure 18: Example of Trash Receptacle at Sheltered Bus Stop

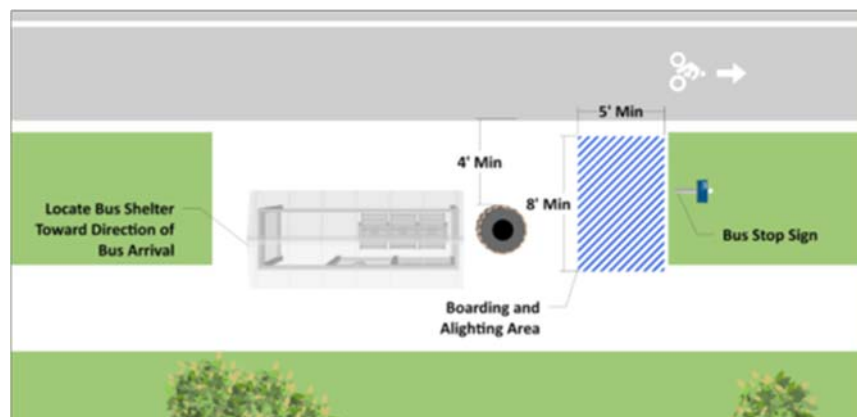

Source: Accessing Transit: Design Handbook for Florida Bus Passenger Facilities, Version III, 2013

Positives

- Bus stop lighting provides safety and security for passengers waiting at bus stop locations and deters criminal activity.
- Adequate lighting while increasing safety also increases the visibility of the development to potential customers.

- Solar and other enhanced lighting features may lead to reduced operating costs.
- Better lighting reduces the chances of the transit bus passing by customers.
- Landscaping provides beautification features and if done properly can add environmental benefits.
- Landscaping can absorb water and decrease flooding.
- Landscaping around bus stops provides natural shade for passengers waiting and can reduce heat levels thereby lowering electricity cost and weather impacts to infrastructure.

Negatives

- Costs associated with maintaining lighting, landscaping, and trash removal while minimal is an additional cost.
- Trash receptacles may be used by non-customers.
- Lighting can attract insects.
- Landscaping around bus stops will require irrigation and maintenance.
- The addition of trash receptacles will require maintenance and trash pickups that will need to be coordinated with the appropriate agency.
- Trash receptacles that are in the heat may create odors at the bus stops.

Sidewalk Connectivity, Paved Walkways, & Bike Lane Access

Design Standards & Facts

Pedestrian entrances to buildings should be oriented towards the sidewalks, transit stops, and other buildings to minimize walking distances between buildings and transit service. When sidewalk connectivity, paved walkways, or bike lane access is provided for access to transit services, the following should apply to the design of those facilities.

- Per the State requirement for an accessible path, the minimum width of the path should be 4’.
- Per FDOT, sidewalks on the State Highway System should have 5’ width (6’ width when on the back of curb); therefore, the FDOT best practice for sidewalks is 6’ width.
- Per ADA, if a sidewalk is < 5’ wide, then a 60”x60” turnaround must be placed every 200’.
- Sidewalk continuity should be provided between the transit stop and adjacent pedestrian facilities.
- Bus stops should be located to take advantage of existing sidewalk and pathway infrastructure.
- Crosswalks should be provided at intersections where bus passengers are required to cross streets to transfer between routes. Pedestrian crosswalks must be lit.
- ADA-compliant curb ramps shall be provided at all crosswalks, both marked and unmarked.
- Detectable warnings are required at sidewalks at intersecting roads, streets, and railroads. FDOT Design Standards, Index 304, includes specific designs for detectable warnings.
- Bicycle lanes are typically located on the right side of the street. FDOT Roadway Design Bulletin 14-17 modified the criteria for bicycle lane facilities to include eleven foot travel lanes for roadways with a divided typical section in or within one mile of an urban area and with a Design Speed of 45 mph or less and establish seven foot Buffered Bicycle Lanes as the standard for marked bike lanes. Bicycle lanes indicated by colored pavement are being used to draw attention to safety hazards at the intersection of bus bays and bicycle lanes.
- When shared-use paths are provided, bus stops should be coordinated so that they are located in proximity to shared use path access points to the roadway. The design of these paths can be found in the American Association of Highway and Transportation Officials (AASHTO) Guide for the Development of Bicycle Facilities.
- Whenever bus stops and/or shelters are located at or near major intersections, audible information devices and accessible pedestrian signals should be considered to communicate sign and signal information to pedestrians with visual disabilities.
- Signing, pavement marking, and signalization of roadways should have the consent of the jurisdictional engineering agency.
- Mid-block crosswalks can be used in locations where there is a major transit-oriented activity center or the distance to the next intersection is greater than 300 feet. These crosswalks should be located so that oncoming traffic is visible to pedestrians, with the crosswalk illuminated for safety purposes. To improve visibility, on-street parking should be prohibited in advance of all mid-block crossings or intersections. If there are a significant number of crossings at the mid-block crosswalk, a signal should be considered.

Positives

- Routes that do not deviate into parking areas limit vehicular/ pedestrian conflicts
- Route on-time performance savings can be improved by not deviating from the main thoroughfare
- Well-defined pathways can create corridors across parking areas and minimize vehicular/ pedestrian conflicts
- Shared use pathways minimize vehicular/pedestrian conflicts by providing paved facilities separated from motorized traffic using an open space or barrier
- Mid-block crosswalks may reduce jaywalking when blocks are long

Negatives

- Routes on the main thoroughfare do not directly access the land uses and require increased walking time and distance from the land use to the bus stop
- When stops are located on the roadway and not near buildings, security may be decreased by limiting indirect surveillance from the land use; however, CPTED principles could assist with natural surveillance at the stops and along the pathways
- Bike lanes may have conflicts with buses on the roadways at bus stops and when buses are using exclusive lanes
- There are safety concerns with mid-block crosswalks relating to visibility; therefore, they should be well marked and illuminated and not located near schools

Figure 19: Pedestrian Pathway to Votran bus stop



Figure 20: Maximum Bike Lane Width

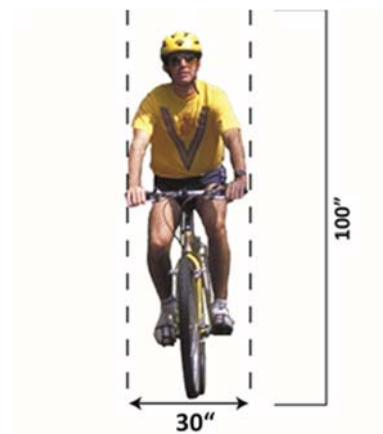

84" Maximum Bike Lane Width

Source: FDOT Accessing Transit, Version III, 2013

Bus Bay/Pull Out & Bulb Outs

Design Standards & Facts

There are limited circumstances when bus pull outs may be considered as an effective option. There are also circumstances when the transit vehicle is not permitted back into traffic after using the bus pull out creating delays and safety issues. Therefore, bus bays or bus pull outs are not recommended except in circumstances where the design is effective for buses with longer dwell times or layovers and the pull out is located near a signalized intersection that provides an opportunity for the bus to reenter the traffic lane. Pull out bays can also be effective on roadways with higher speeds and should still be placed near signalized intersections for safer bus travel and passengers.

If the development thresholds checklist indicates that bus bay infrastructure should be incorporated, the developer should further coordinate with the local jurisdiction to determine if the bus bay is justified based on the roadway operating speed, number of bus-related crashes, land uses, right-of-way width, and the existing public transportation service levels. If the bus bay design is for an urban area with higher traffic volumes and congestion levels, such as those identified in the transit corridors section of this document, in addition to bus bays, signal transit priority may also be appropriate as further detailed in Appendix D. If bus bays are considered a need that should be incorporated into the site plan, they should be located on the far side of a signalized intersection. The traffic signal will create the critical gap needed for bus re-entry into traffic. Acceleration/deceleration lanes should be provided to ease the transition into and out of traffic. Near-side bus bays should be avoided because of conflicts with right-turning vehicles and delays in service resulting from the difficulty associated with bus re-entry into the travel lane. Bus bays should also meet all requirements in the PPM, Florida Greenbook, and FDOT Design Standards.

The five typical elements of bus bay designs are listed below. Please see the bus B&A requirements sections for additional information on the requirements for the ADA-compliant B&A area.

1. An entrance taper (length varies depending on through speed of the adjacent travel lane and the speed of the bus entering the bus bay)
2. A deceleration lane (length varies depending on through speed of the adjacent travel lane and the speed of the bus entering the bus bay)
3. The stopping area (should allow 50 feet)
4. An acceleration lane (length varies depending on through speed of the adjacent travel lane and the speed of the bus entering the bus bay)
5. An exit taper (length varies depending on through speed of the adjacent travel lane and the speed of the bus entering the bus bay)

Table 5 presents the required lengths and speeds for bus bays. Bus bays must meet all requirements in the PPM, Florida Greenbook, and FDOT Design Standards. Additional design considerations for bus bays are located in Appendix D. Figures 21 and 22 represent an example of a closed bus bay and the closed bus bay located at Votran's Amelia Avenue stop.

Table 5: Bus Bay Lengths and Speeds

Through Speed (mph)	Enter Speed (mph)	Entrance Taper (feet)	Decel. Lane (feet)	Stopping Area (feet)	Accel. Lane (feet)	Exit Taper (feet)	Total (feet)
<30	<20	5:1 min	None	50	None	3:1 max	130 min
35	25	170	165	50	250	170	805
40	30	190	265	50	400	190	1,095
45	35	210	360	50	700	210	1,530
50	40	230	470	50	975	230	1,955
55	45	250	595	50	1,400	250	2,545
60	50	270	735	50	1,900	270	3,225

Source: Accessing Transit: Design Handbook for Florida Bus Passenger Facilities, Version III, 2013

Figure 21: Closed Bus Bay Example



Figure 22: Votran Closed Bus Bay Example



Source: Accessing Transit: Design Handbook for Florida Bus Passenger Facilities, Version III, 2013 and Votran.

Bus bulbs are extensions of the sidewalk into the parking lane that allow buses to make curbside stops without weaving in and out of the travel lane. Buses are able to hold their place in traffic by not entering a bus bay resulting in a reduced time to reenter traffic. Bus bulbs should be designed to include the following standards:

- B&A areas and amenities should be provided for passengers waiting for the bus.
- Bus bulbs should not be used on roadways with high volumes or speeds greater than 45 mph due to the potential for vehicle stacking to become problematic.
- Bulbs are best used on the near-side of signalized intersections in areas where buses experience delays in re-entering the traffic lane.
- Bus bulbs may be incorporated where traffic volume will be relatively low and on streets with more than two lanes.
- Bus bulbs should be a minimum of 6' wide, with a 2' offset between the bulb and the edge of the travel lane, and long enough to accommodate simultaneous boarding of several buses, if required.

Figure 23: Example of Bus Bulb

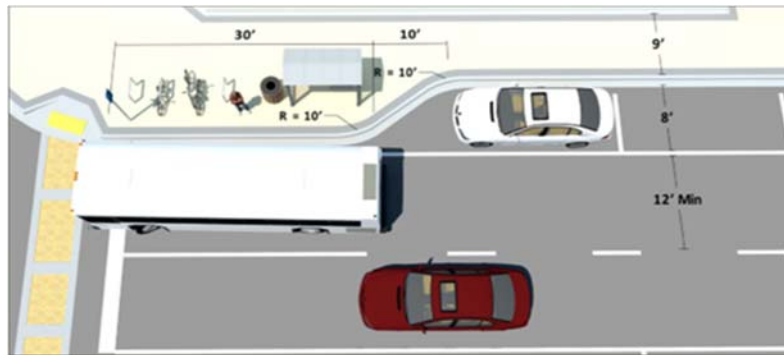

Source: Accessing Transit: Design Handbook for Florida Bus Passenger Facilities, Version III, 2013

Positives

- Bus bays create increased safety for passengers by adding distance between the travel lane and waiting passengers.
- Bus bays reduce vehicle stacking on roadways with higher frequency and greater traffic speeds.
- Bus bays accommodate vehicle layovers for transferring passengers.
- Bus bulbs provide traffic calming at intersections.
- Bus bulbs do not reduce the ability to have on-street parking, where needed and permitted by local and state codes.

Negatives

- The construction of bus bays will require coordination with multiple agencies and greater planning and construction timeframes for implementation.
- The construction of bus bays will require right-of-way that may not be available in urban environments where corridors are constrained such as A1A and US Hwy 1.
- Buses may experience difficulty reentering traffic from the bus bay; however, designing the closed bus bay on the far side of a signalized intersection is preferred to allow buses easier reentry into traffic.
- Bus bulbs may not be effective in areas with higher boardings of wheelchair dependent passengers, as boardings may result in vehicle stacking when boardings require more time than intersection delays.
- Bus bulbs may create conflicts for bicyclists.

Major Transfer Centers & Park-and-Rides

Design Standards & Facts

Major transfer centers may be required when major activity centers are constructed that would result in high transit use. Transfer centers accommodate passenger transfers in areas where multiple routes converge and typically offer greater passenger amenities, including ticketing, vending, and public restrooms. According to the FDOT Accessing Transit manual, design characteristics that are associated with a typical transfer center are listed below. Figure 24 presents a prototype of a typical transfer center and Figure 25 illustrates Votran’s DeLand Intermodal Transfer Center.

- Adjacent land uses typically include commercial or mixed-use zones in a major retail activity center.
- The site area for a major transfer center should be approximately 1.25 acres.
- The nearby street characteristics should include intersections of major arterials and highway interchanges. Street side elements should be off-line center with dedicated bus travel lanes and half-sawtooth bus bays.
- Curb-side elements should include sheltered bus stops with benches and trash receptacles, bus B&A areas, bicycle parking facilities, landscaping, and public art.
- Accessible bicycle and pedestrian routes should connect to the bus B&A areas, surrounding infrastructure, bicycle parking areas, and provide access to bicycle lanes/shared use paths.

Figure 24: Example of Typical Transfer Center



Figure 25: Votran’s DeLand Transfer Center



There are three types of park-and-ride lots: suburban lots (served by express routes and located near passengers’ homes), peripheral lots (located at the edges of an activity center), and joint-use lots (located near developments that are not generally used during the workday and along major corridors). The design characteristics of typical park-and-ride lots from FDOT’s Accessing Transit guidelines are listed below.

- Park-and-ride lots allow all-day parking for commuters and should be located within 300 feet of bus loading zones.
- Street characteristics are usually major arterials that serve as commuting corridors.
- The number of parking spaces is determined on the basis of current and future ridership; approximately 90 to 100 spaces per acre are reasonable for such facilities.
- Designated spaces for ADA-accessible parking must be located closest to the loading area and must include accessible connections to amenities throughout the facility.

- Curb-side elements usually include sheltered stops with benches and trash receptacles, transit B&A areas, bicycle parking facilities, trash receptacles, and route information. Electric car charging stations may also be included at park-and-rides sites.

Examples of park-and-ride facilities are shown in Figures 26 and 27. More detailed guidance on the site assessment and design of park-and-ride facilities can be found in the FDOT State Park-and-Ride Guide located at <http://www.dot.state.fl.us/transit/Pages/FinalParkandRideGuide20120601.pdf>.

Figure 26: Example of Bus Facilities at Park-and-Ride



Figure 27: Saxon Boulevard Park-and-Ride



Positives

- Allow multiple modal options for commuters.
- Can increase activity to nearby uses (i.e., when changing/returning to vehicle may grab a coffee or pickup groceries).
- Reduce roadway congestion by removing cars from the road.
- Provides opportunity for social interaction through carpooling, vanpooling, etc.
- Provides opportunity for use of vacant or unused land that could reduce vagrancy, trespassing, etc.

Negatives

- Requires the use of more land.
- Costs associated with maintenance.
- Costs associated with construction.

Appendix A: Technical Design Standards for Accessible Bus Stops

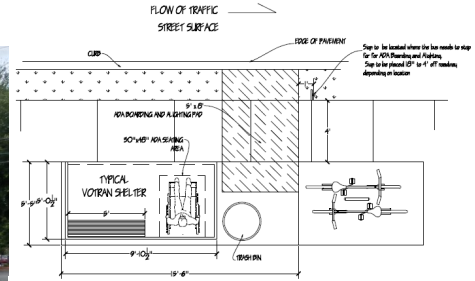

TECHNICAL DESIGN STANDARDS FOR ACCESSIBLE BUS STOPS

PREPARED FOR
VOLUSIA COUNTY GOVERNMENT
VOTRAN PUBLIC TRANSIT SYSTEM
JANUARY 2013

TECHNICAL DESIGN STANDARDS FOR ACCESSIBLE BUS STOPS

TABLE OF CONTENTS

1.0 Introduction	4
1.1 Overview	4
1.2 Disclaimer.....	5
2.0 Bus Stop Design Prototypes	6
2.1 Overview	6
2.2 Basic Bus Stop Grade and Slopes	7
2.3 Curb without Sidewalk or Path	8
2.4 No Curb - without Sidewalk or Path	9
2.5 Curb and Sidewalk.....	10
2.6 Curb and Sidewalk w/ Extension.....	11
2.7 Curb w/ Grass, Sidewalk, or Path	12
2.8 No Curb w/ Grass, Sidewalk, or Path.....	13
2.9 No Curb w/ Grass, Sidewalk, or Path w/ Extension.....	14
2.10 Curb w/ Grass, Sidewalk, or Path Behind Bench	15
2.11 Curb w/ Grass and Sidewalk w/ Connector	16
2.12 No Curb w/ Grass and Sidewalk w/ Connector	17
2.13 Shelter w/ Bench, Trash Bin & Bike Rack	18
2.14 Shelter w/ Bench and Trash Bin.....	19
2.15 Shelter w/ Bike Pad and Trash Bin	20
3.0 General Accessibility Guidelines	21
3.1 Elements of an Accessible Environment	21
Accessible Pedestrian Routes	21
Surfaces and Sidewalks	22
Protruding Objects.....	22
Curb Ramps	22
Bus Stops.....	22
3.2 Specific ADAAG Requirements for Bus Stops & Facilities	24
Figure 3.2.1 Dimensions of Bus Boarding and Alighting Areas	24
Figure 3.2.2 Bus Shelters	25
Figure 3.2.3 General Bus Stop Site Design Characteristics	26
4.0 Research & Findings	27
4.1 Code Applicability Discussion for Bench Placement at Bus Stops	27

TECHNICAL DESIGN STANDARDS FOR ACCESSIBLE BUS STOPS

TABLE OF CONTENTS

4.2	ADAAG Section 903 Requirements	28
	Figure 4.2.1 ADAAG Figure 903.4 Bench Back Support	28
4.3	Public Rights-of-Way Accessibility Guidelines	29
4.4	Florida Accessibility Code: Placement of Transit Bus Benches.....	31
5.0	Design Standards & Scenarios	33
5.1	Priority Considerations for Bench and Shelter Placement at Bus Stops	33
5.2	Guidelines for Bench Placement	35
	Figure 5.2.1 Accessible Bus Stop Site Layout Design	37
	Figure 5.2.2 Bench Placement Scenario One.....	41
	Figure 5.2.3 Bench Placement Scenario Two.....	42
	Figure 5.2.4 Bench Placement Scenario Three	43
	Figure 5.2.5 Bench Placement Scenario Four	44
	Figure 5.2.6 Bench Placement Scenario Five.....	45
6.0	Definitions & Acronym List	46
7.0	References	51

1.0 INTRODUCTION

1.1 OVERVIEW

Volusia County's public transit system, Votran, is interested in improving access and control of bus stops established throughout its service area, as well as providing comprehensive guidance and standards for the placement, maintenance, and usability of related bus stop amenities to other entities that are allowed to place bus stops and amenities in the public right-of-way. This document will address the accessibility of bus stops and the placement of amenities at bus stops in accordance with applicable requirements of the ADAAG (Americans with Disabilities Act Accessibility Guidelines) as revised and published by the U.S. Access Board on July 26, 2004, and adopted as regulatory requirements by the U.S. Department of Transportation on November 29, 2006, as well as in consideration of the Florida Building Code, Chapter 11, 2012 Florida Accessibility Code (FAC) (effective March 15, 2012).

To ensure a consistent approach to siting, placing, maintaining, and meeting standards related to transit stops and amenities, these guidelines for the design and placement of bus stops have been developed. The standards and design templates included in this document have been developed with respect to the requirements of the ADAAG, the FAC, and, where applicable, those standards adopted by Florida Department of Transportation (FDOT) from the Public Rights-of-Way Accessibility Guidelines issued by the U.S. Access Board. These standards and requirements help address issues related to the accessibility of bus stop facilities when placed in the public right-of-way. The standards include the following categories:

- Pedestrian access pathways
- Wheelchair maneuvering clearances
- Design characteristics
- Placement characteristics for bus stop passenger access

The goal of this design document is to promote consistency in bus stop placement and design throughout the Votran transit service area and to encourage the use of the stops by the general public and individuals with disabilities.

This document is intended as a design guide to be used to meet Federal, FDOT, and local standards as they exist based on the date of issue.

Consideration of existing Votran bus stop design standards and operational guidelines as detailed in the August 29, 2007, "Votran Transit Development Design Guidelines" manual as it pertains to the placement and design of bus stops has not been incorporated in this document except where changes in code compliance have occurred to accommodate those materials previously used by Votran staff in the design, maintenance, repair, and placement of bus stops. It must be noted that the 2007 document references the FDOT Accessing Transit guidelines (March 2004) for design guidance. The Accessing Transit guidelines were updated in 2008 and, as of this writing, this handbook is undergoing another update to include the ADAAG and FAC code changes occurring since 2004, among other enhancements.

1.0 INTRODUCTION

1.2 DISCLAIMER

The guidelines included in this document are intended to provide general parameters for personnel and organizations when designing and placing bus stops and amenities in the public right-of-way. This document is not intended to be an engineering design manual, and it does not provide site-specific detailed public transit, engineering, architectural, construction, or legal information. Users of this document will need to adjust the information contained in the guidelines to site-specific needs, constraints, and applicable laws, regulations, and ordinances. If a user desires expert advice concerning any of the information in these guidelines, the user is encouraged to retain the services of an appropriate expert.

Some bus stops, public seating benches, and other amenities at bus stops currently in place in the public domain at existing Votran transit facilities are inconsistent with the goals and guidelines presented in this document. In some instances, bus stop conditions and placement are defined by the underdeveloped corridors or roads they serve. In these cases, application of the design guidelines in this document may be limited by a lack of right-of-way development, constraints due to the natural terrain, unimproved roadways with no infrastructure (e.g., curb, gutter, drainage, sidewalks, etc.), or because of the policies and standards of the jurisdiction in which the bus stop is located. Because of these conditions, Votran may not be able to improve the public right-of-way sufficient to support an accessible bus stop placement until such time as major improvements are planned and funded. The facilities can best be improved through a coordinated planning and design effort between Votran and the local agencies responsible for maintaining and upgrading the roadway and pedestrian rights-of-way.

Votran has a responsibility to ensure that bus stops and amenities are placed in a manner that provides access and use by individuals with disabilities and must, therefore, use non-discriminatory judgment when planning for the placement of bus stops for public use. This judgment may result in refusal by Votran to either place or allow placement of a bus stop at a desired location because site conditions prevent an accessible environment resulting in a non-accessible transit stop. Establishment of a new bus stop at a site where full access is afforded is mandated by the ADA.

2.0 BUS STOP DESIGN PROTOTYPES

2.1 OVERVIEW

Successfully providing transit that is accessible to all individuals requires a balanced mix of local and state agency coordination and consideration regarding needs, costs, location, federal and state regulations, public relations, and transit-dependent populations. Better accessibility within the bus stop area ensures a comfortable and safe movement of passengers at a bus stop. Mobility aid users, older adults, individuals with disabilities, and passengers needing assistance (such as parents and care givers with strollers and shoppers with bags) will have less difficulty boarding and alighting the bus when there is a level and unobstructed area. ADA standards require all bus stops to have sufficient space for a boarding and alighting area that has a firm, stable, and slip-resistant surface to accommodate boarding and alighting at the stop.

The following section contains design prototypes for ADA-compliant bus stops, including the coordination of bus stop elements such as bus stop signs, benches, and shelters. Any contracted improvements at Votran bus stops in Volusia County are required to meet the design criteria specified in these prototypes.

2.0 BUS STOP DESIGN PROTOTYPES

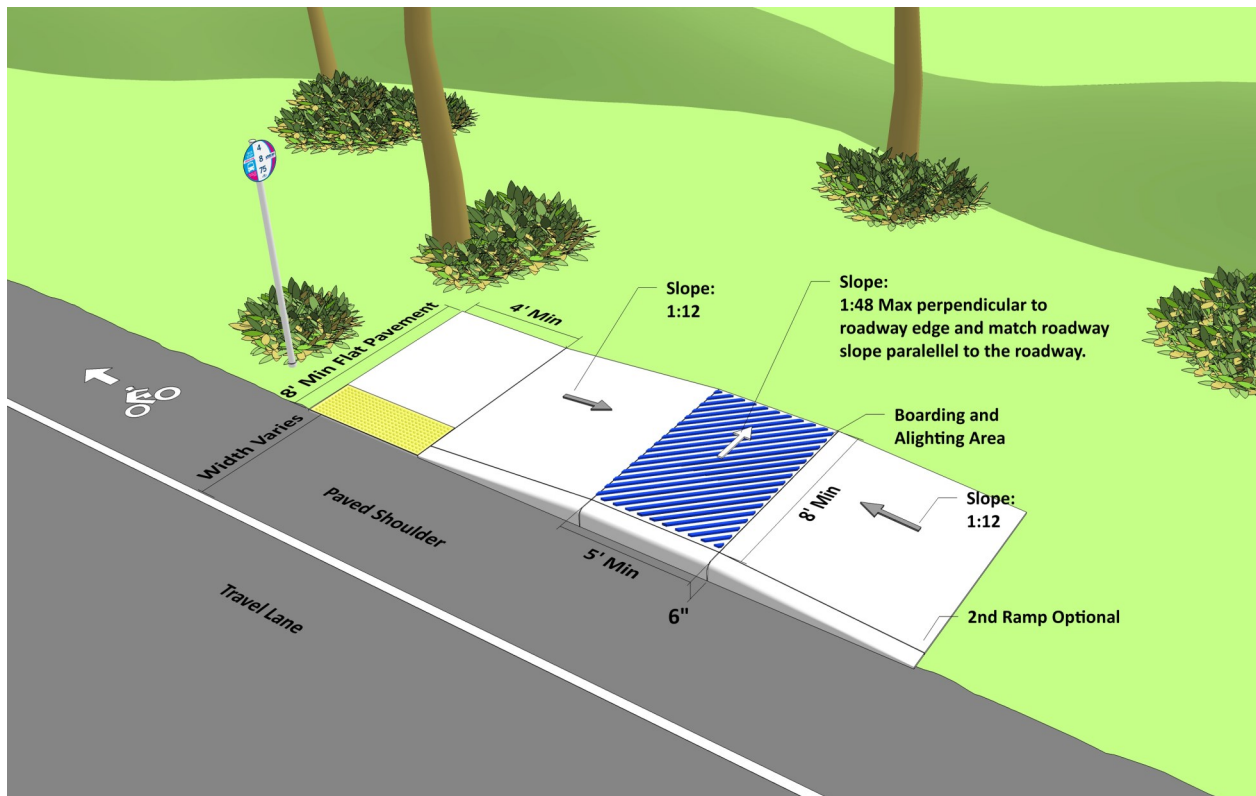
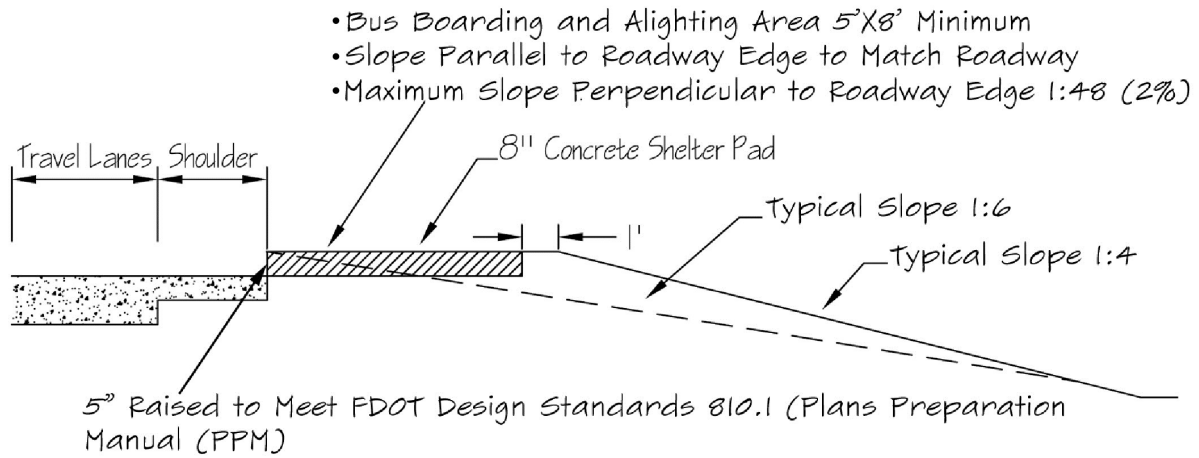

2.2 Basic Bus Stop Grade and Slopes

2.0 BUS STOP DESIGN PROTOTYPES

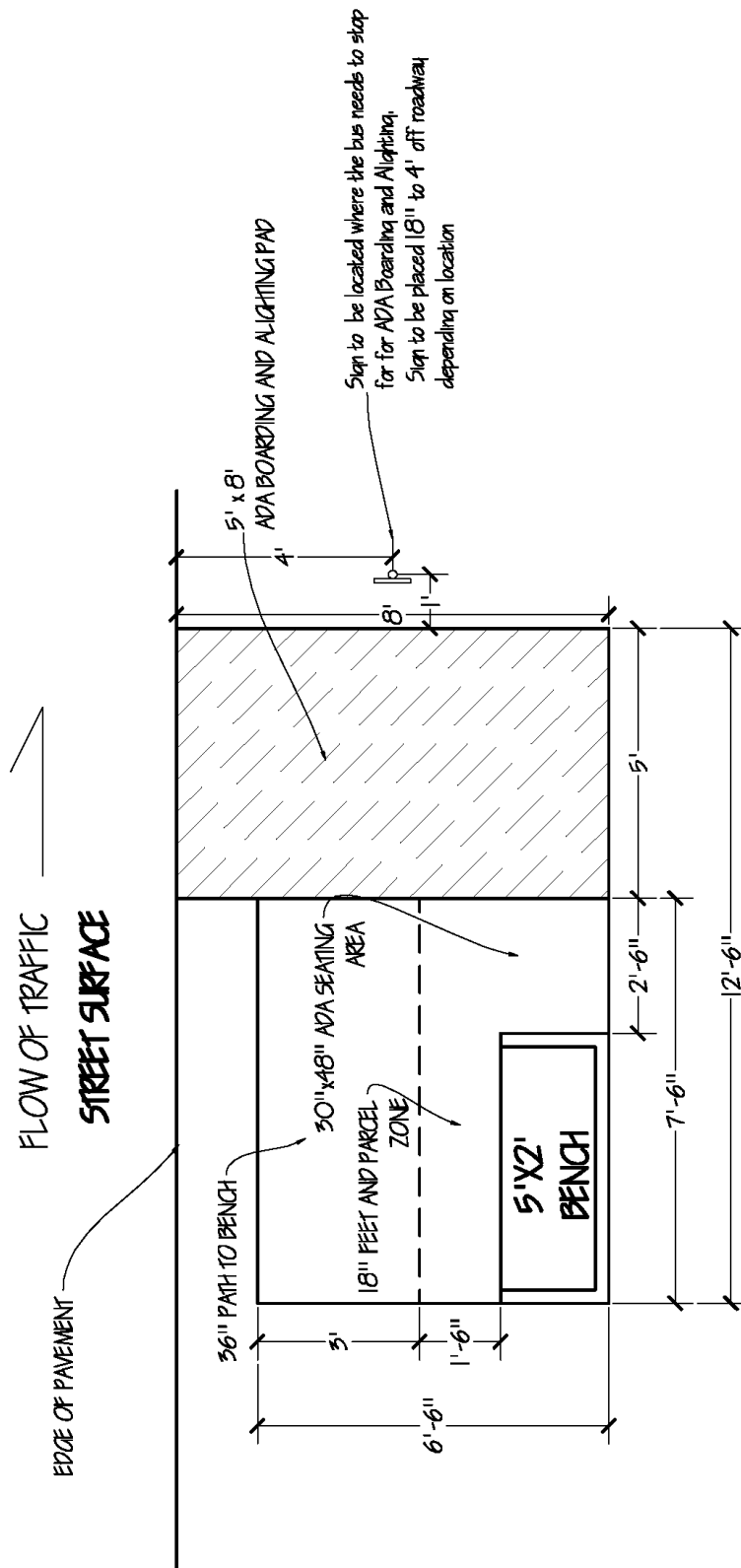

2.3 Bus Bench Pad with No Curb, Sidewalk, or Path

2.0 BUS STOP DESIGN PROTOTYPES

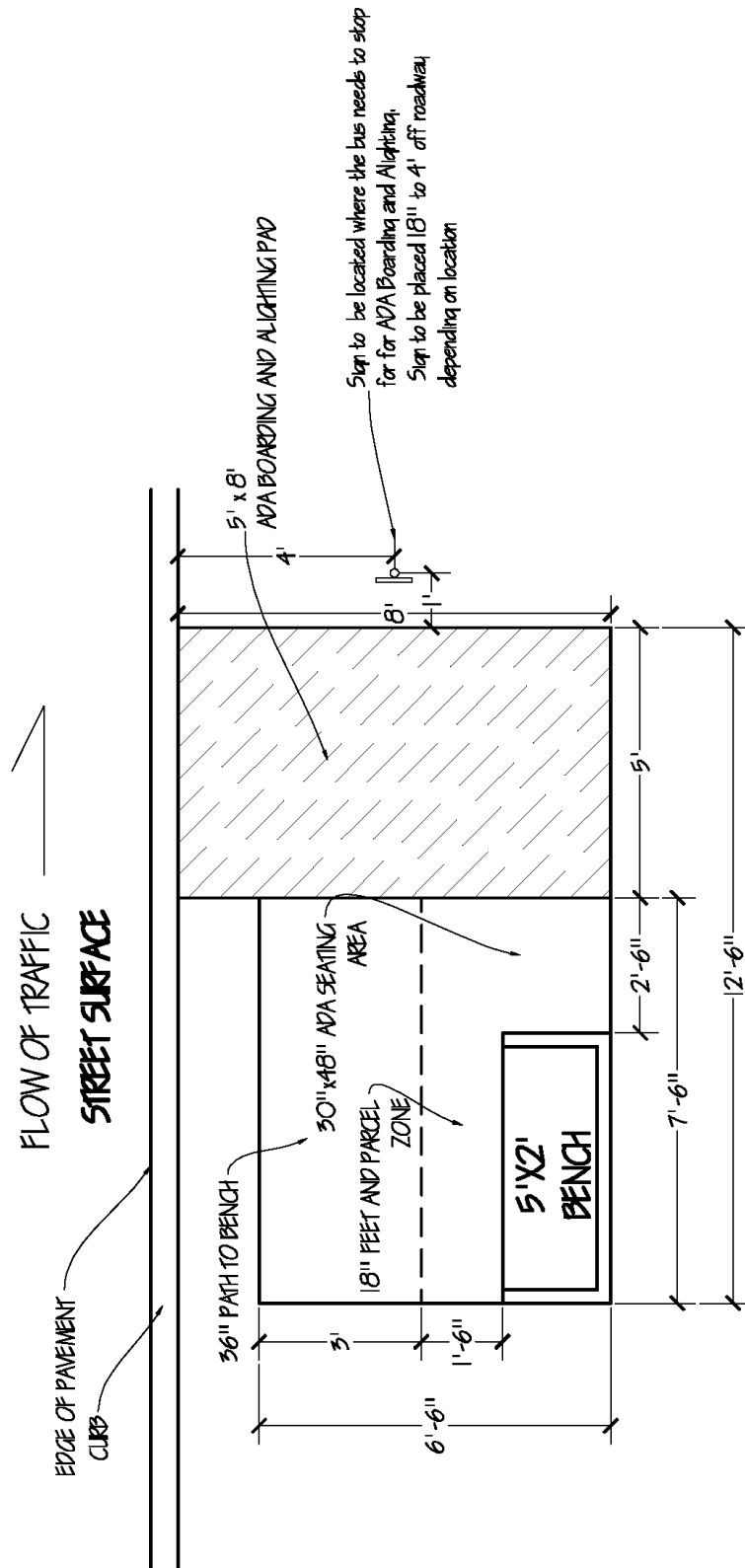

2.4 Bus Bench Pad, No Curb, No Sidewalk or Path

2.0 BUS STOP DESIGN PROTOTYPES

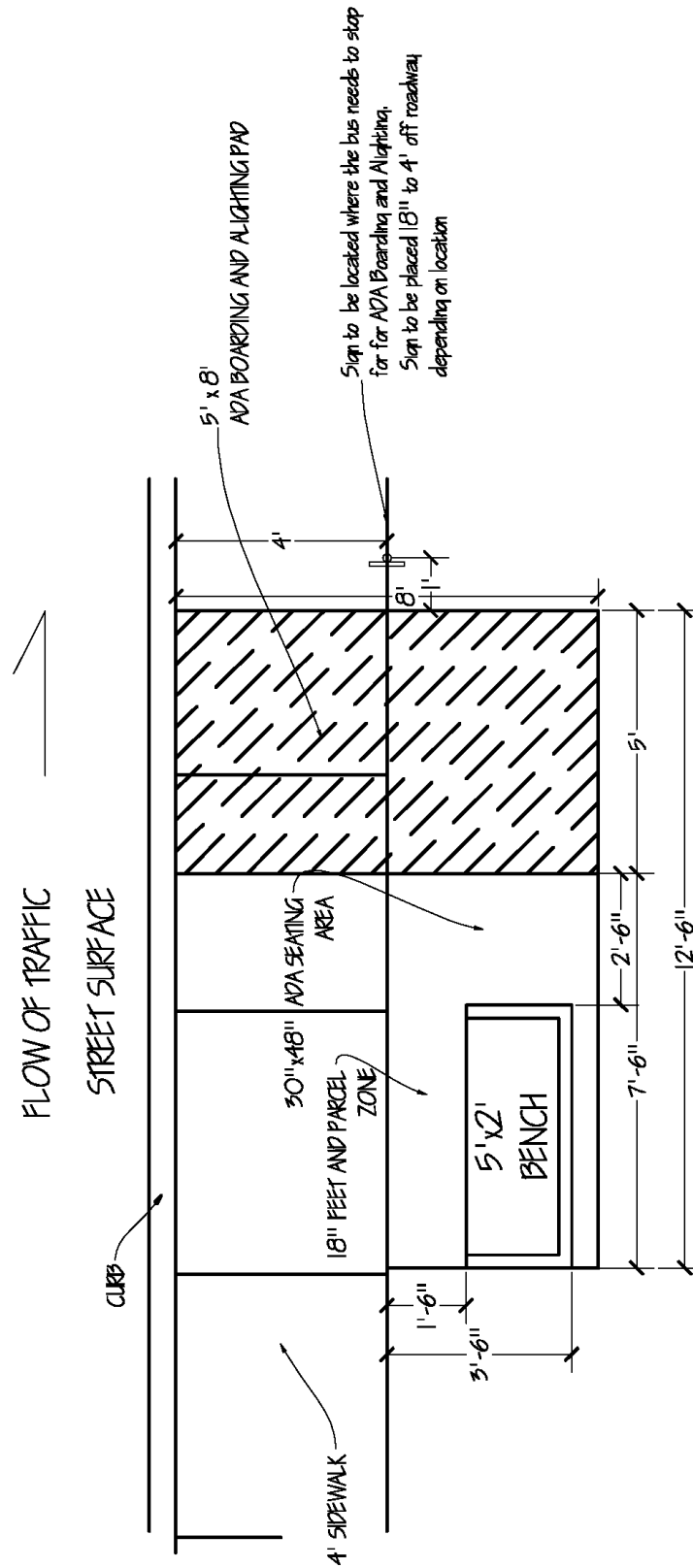

2.5 Bus Bench Pad with Sidewalk Adjacent to Curb

2.0 BUS STOP DESIGN PROTOTYPES

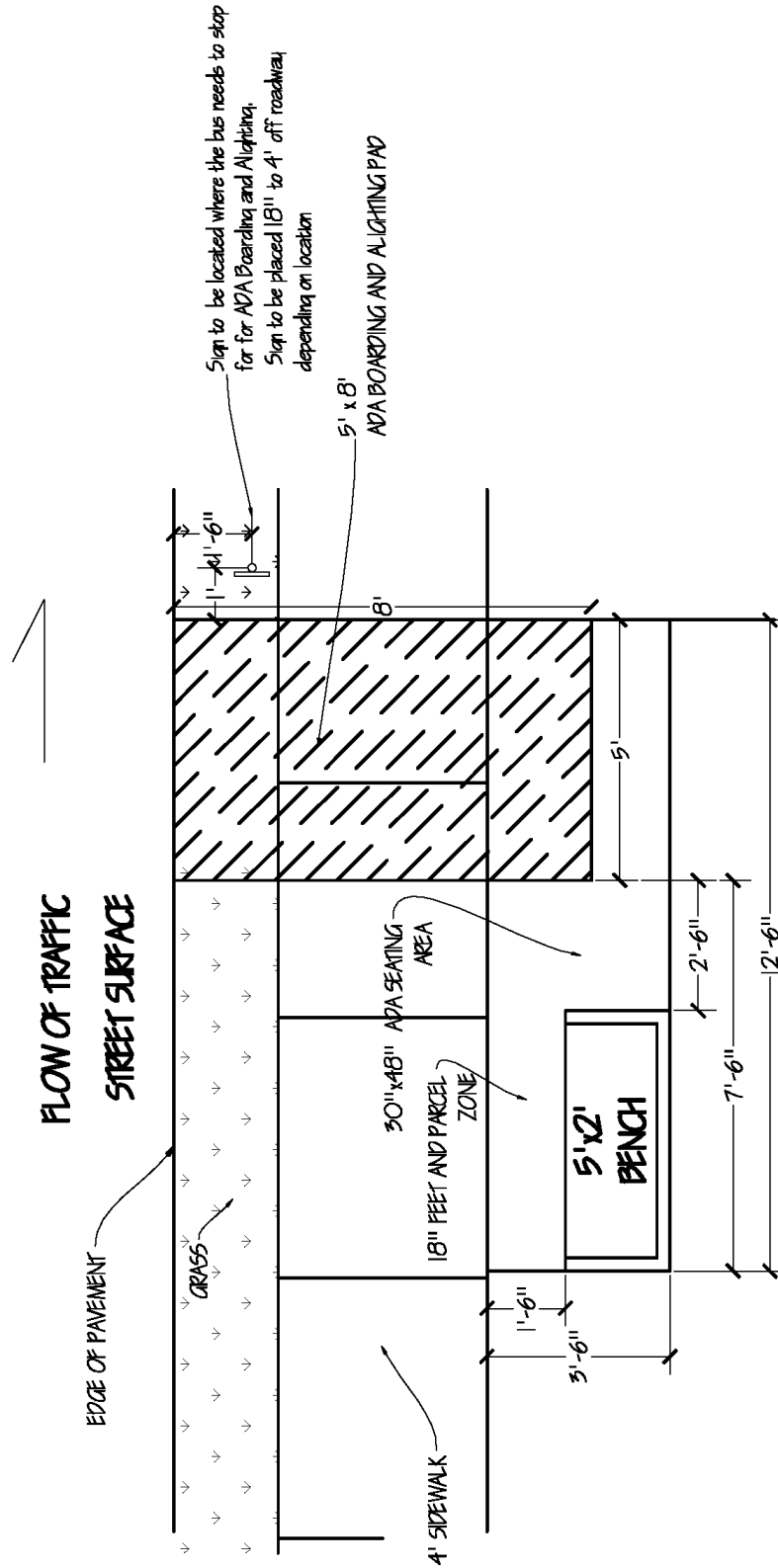

2.6 Bus Bench Pad with Sidewalk No Curb

2.0 BUS STOP DESIGN PROTOTYPES

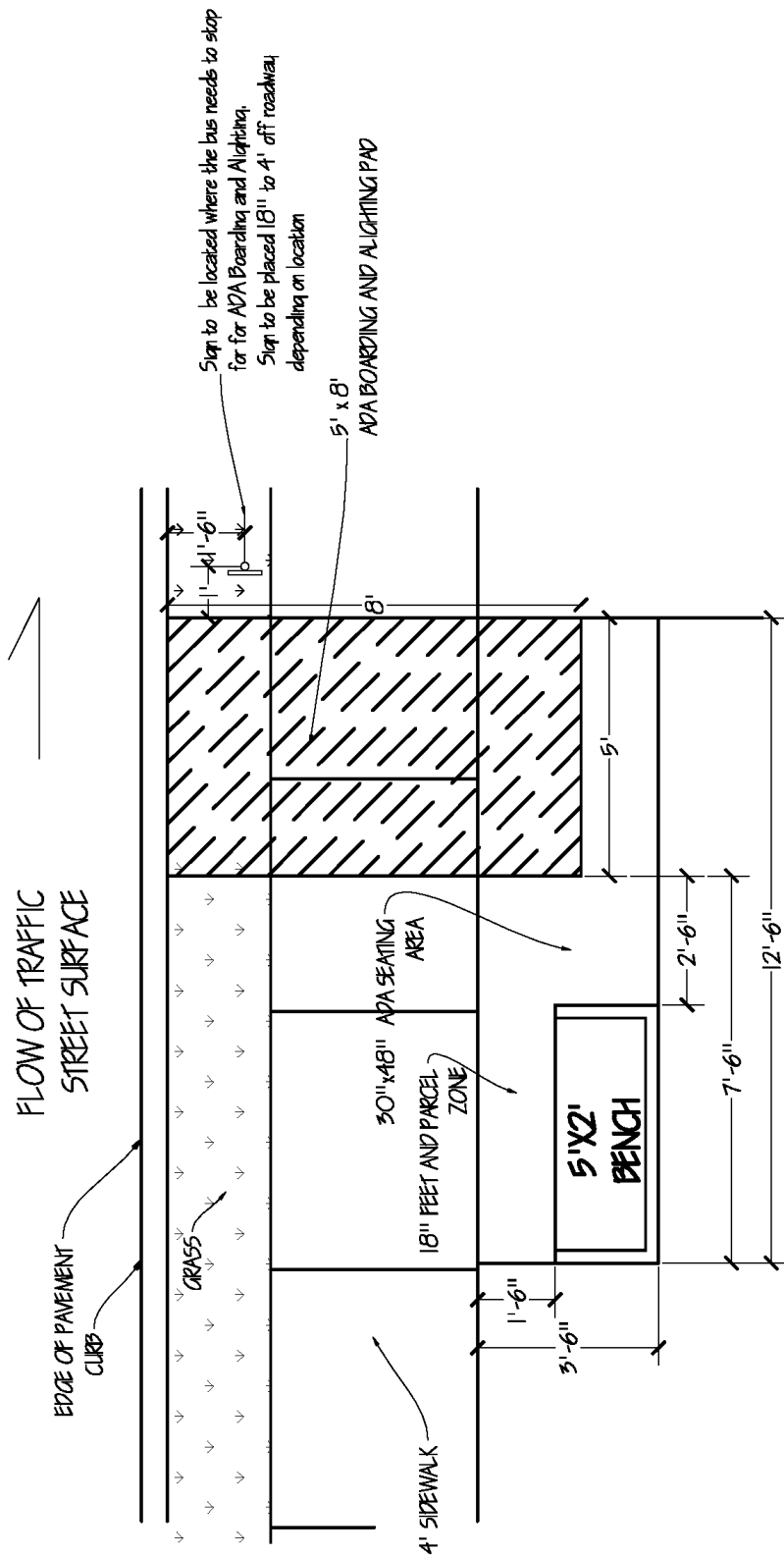

2.7 Bus Bench Pad without Curb, Sidewalk Behind Pad

2.0 BUS STOP DESIGN PROTOTYPES

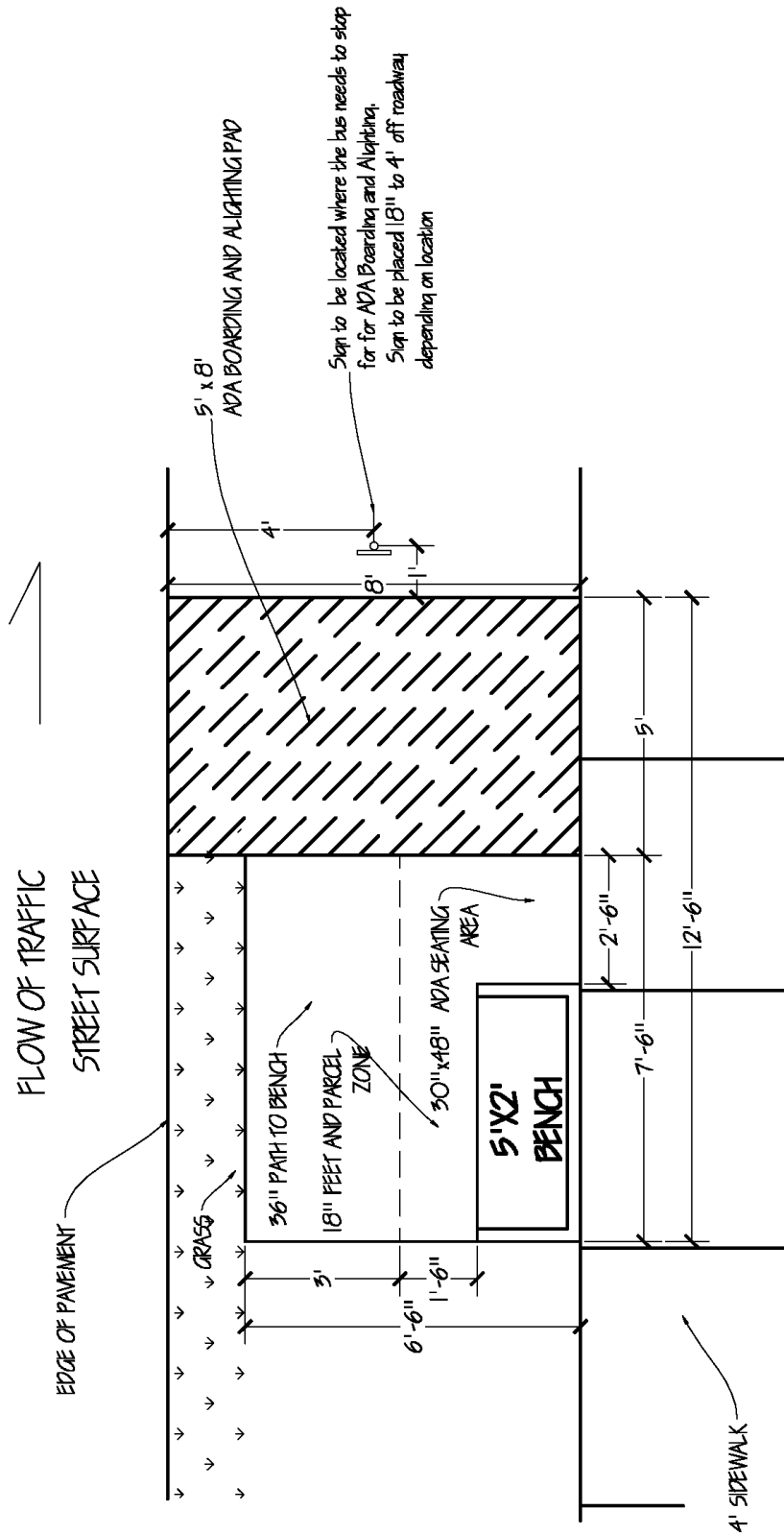

2.8 Bus Bench Pad with Sidewalk and Curb

2.0 BUS STOP DESIGN PROTOTYPES

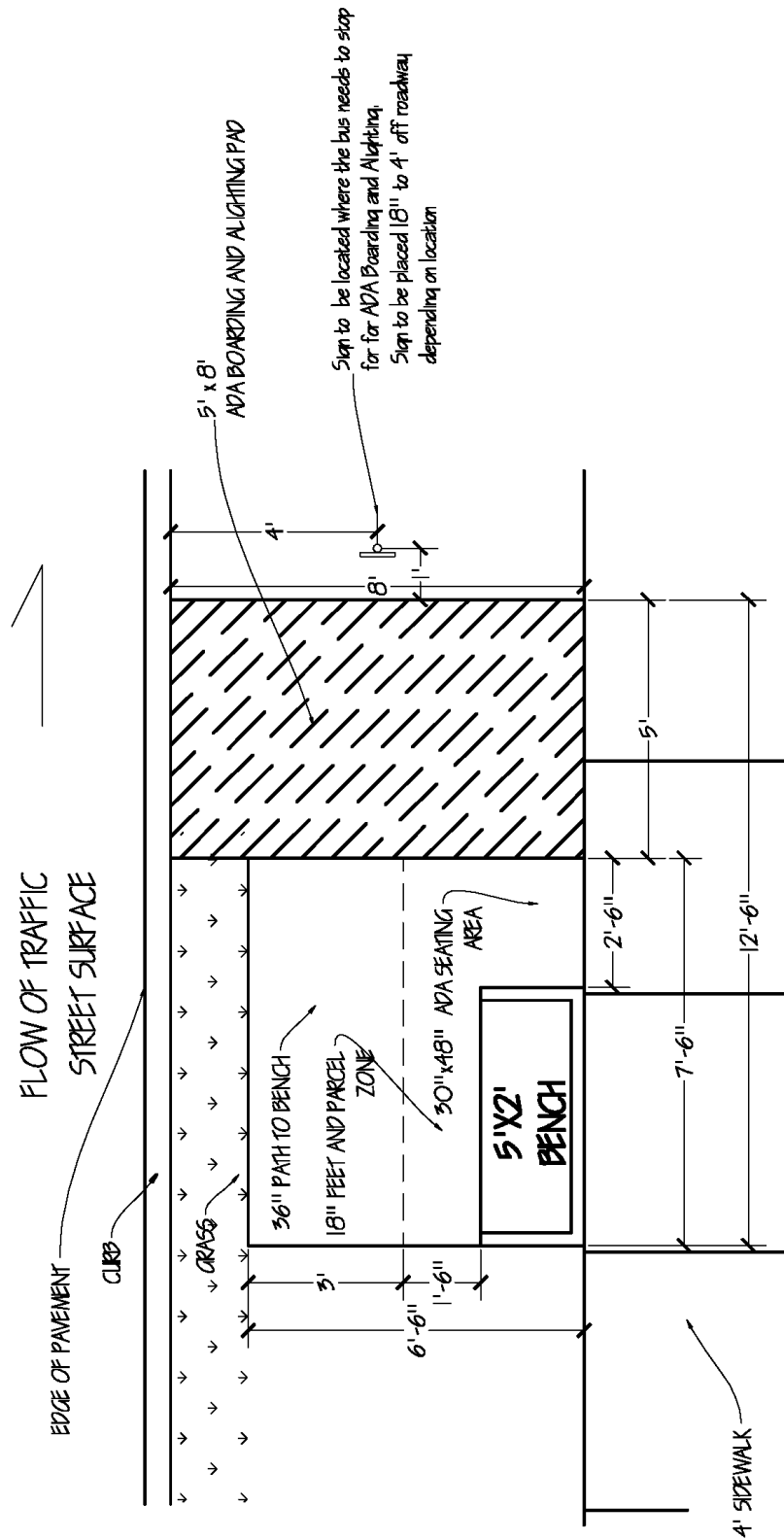

2.9 Bus Bench Pad with Curb, Sidewalk Behind Pad

2.0 BUS STOP DESIGN PROTOTYPES

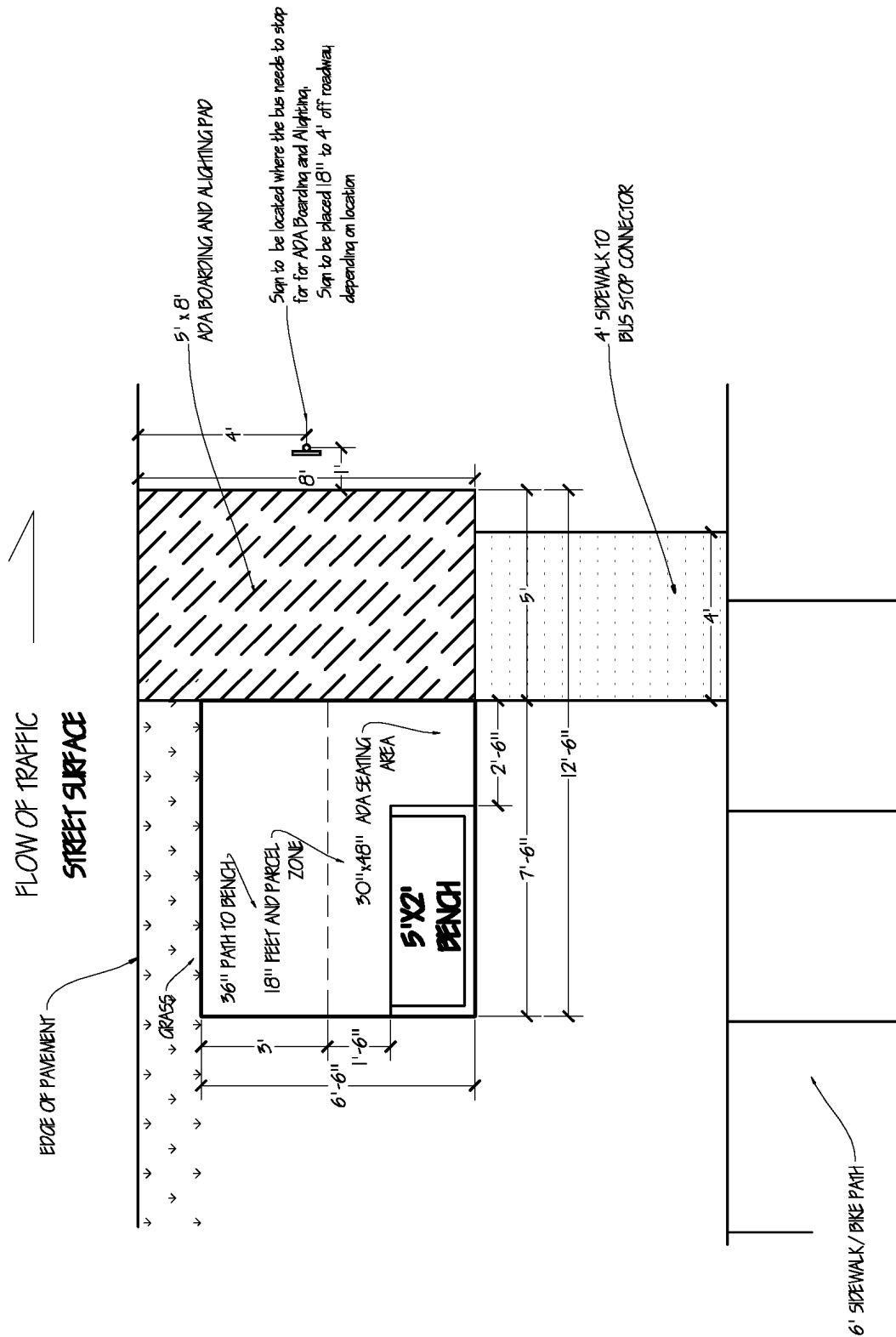

2.10 Bus Bench Pad w/o Curb, Sidewalk Behind Pad w/ Connector

2.0 BUS STOP DESIGN PROTOTYPES

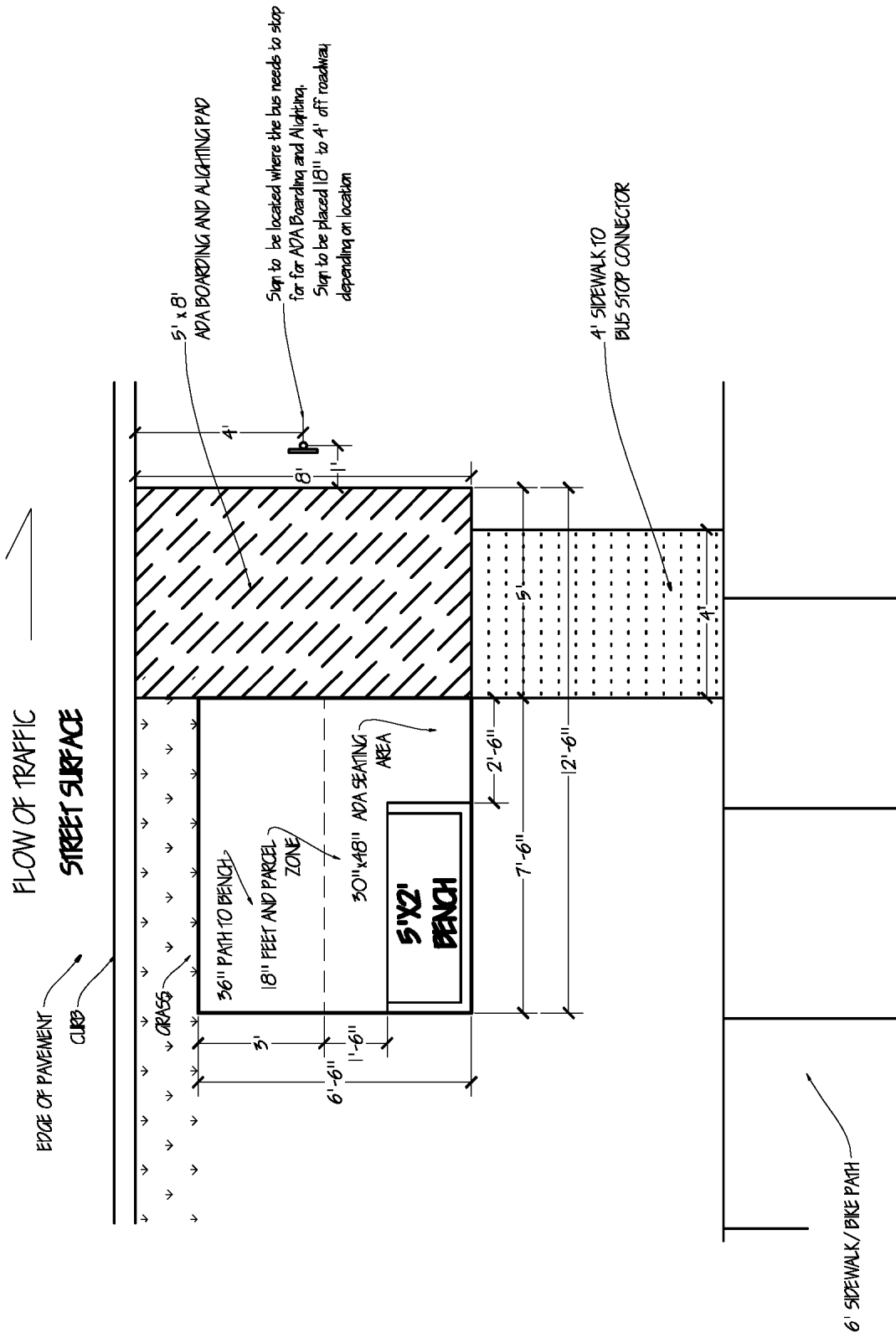

2.11 Bus Bench Pad w/ Curb, Sidewalk Behind Pad w/ Connector

2.0 BUS STOP DESIGN PROTOTYPES

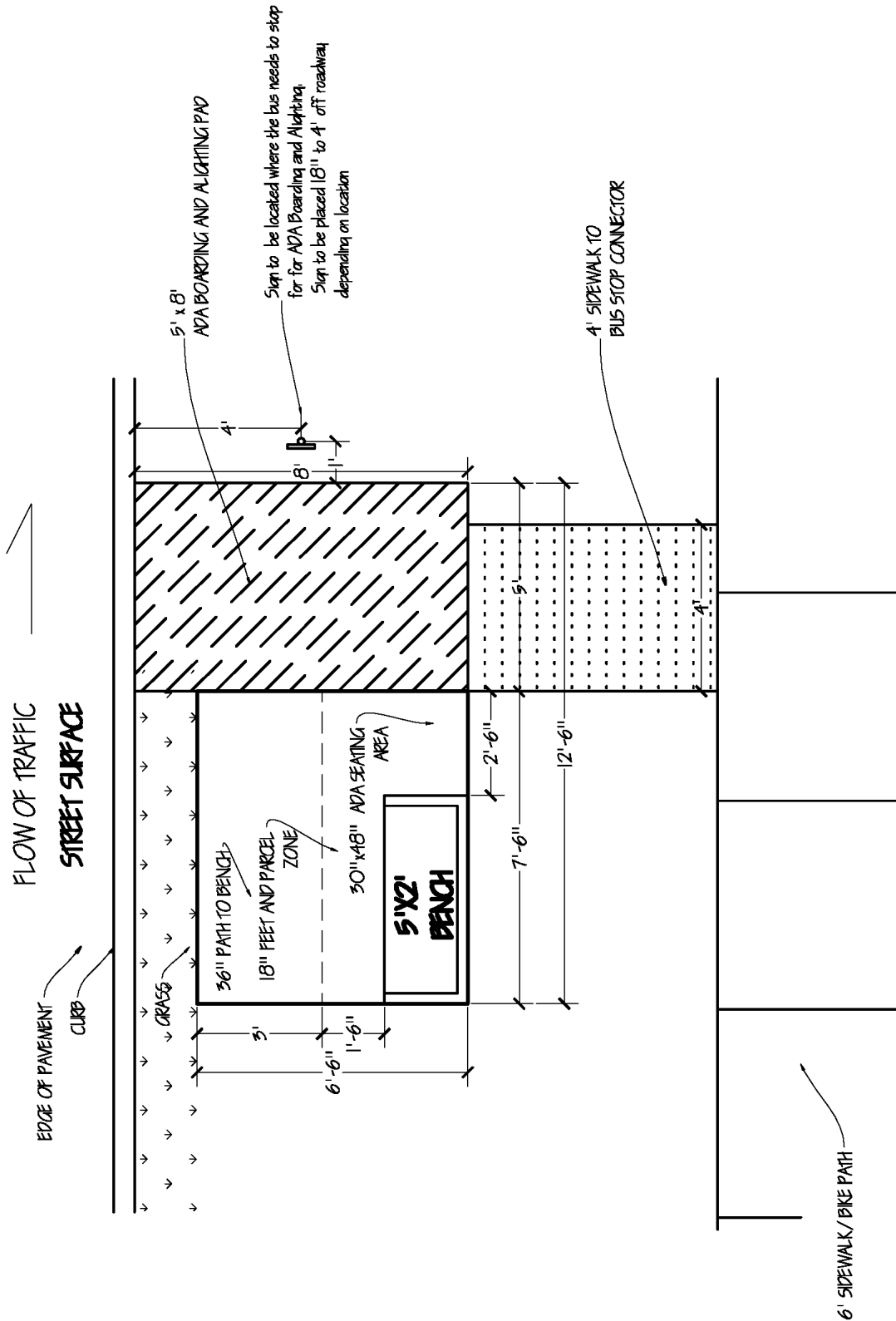

2.12 Bus Bench Pad w/ Curb, Sidewalk w/ Bike Rack

2.0 BUS STOP DESIGN PROTOTYPES

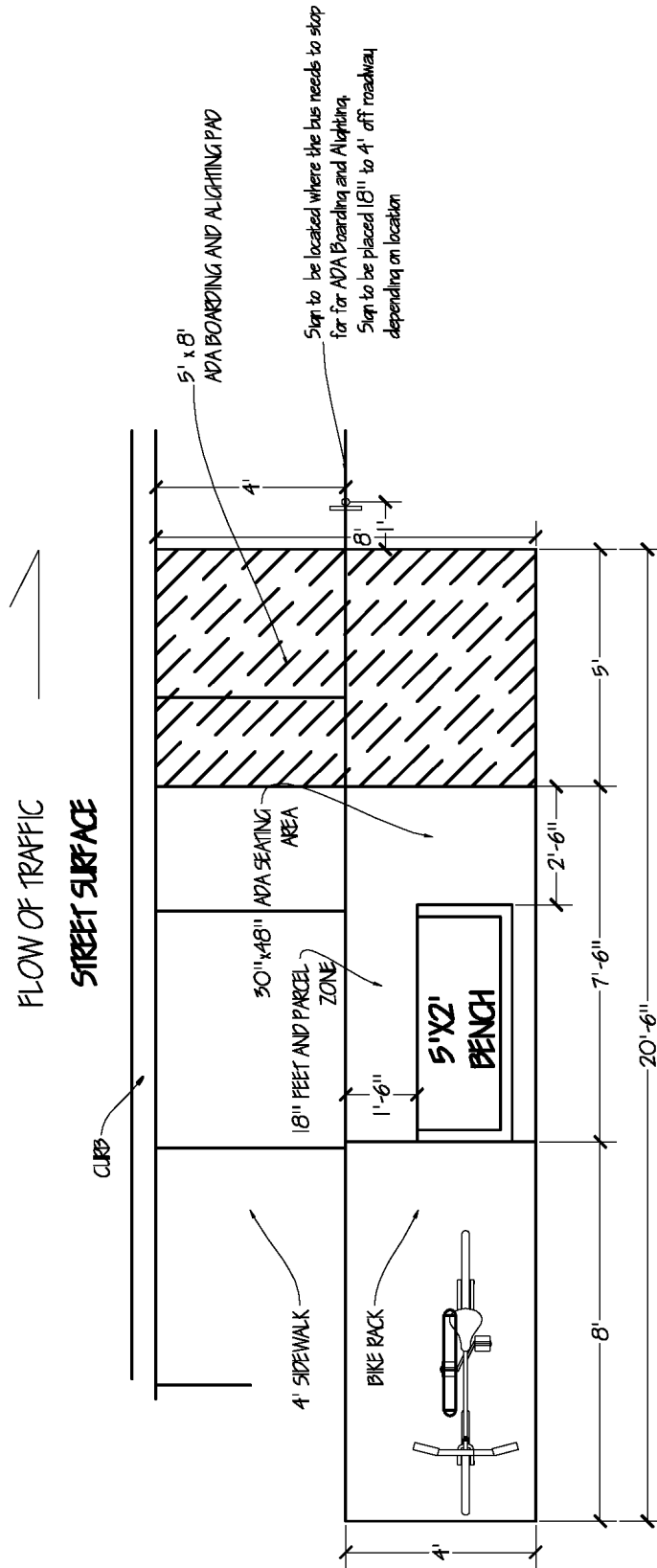

2.13 Bus Bench Pad w/ Curb, w/o Sidewalk, w/ Bike Rack

2.0 BUS STOP DESIGN PROTOTYPES

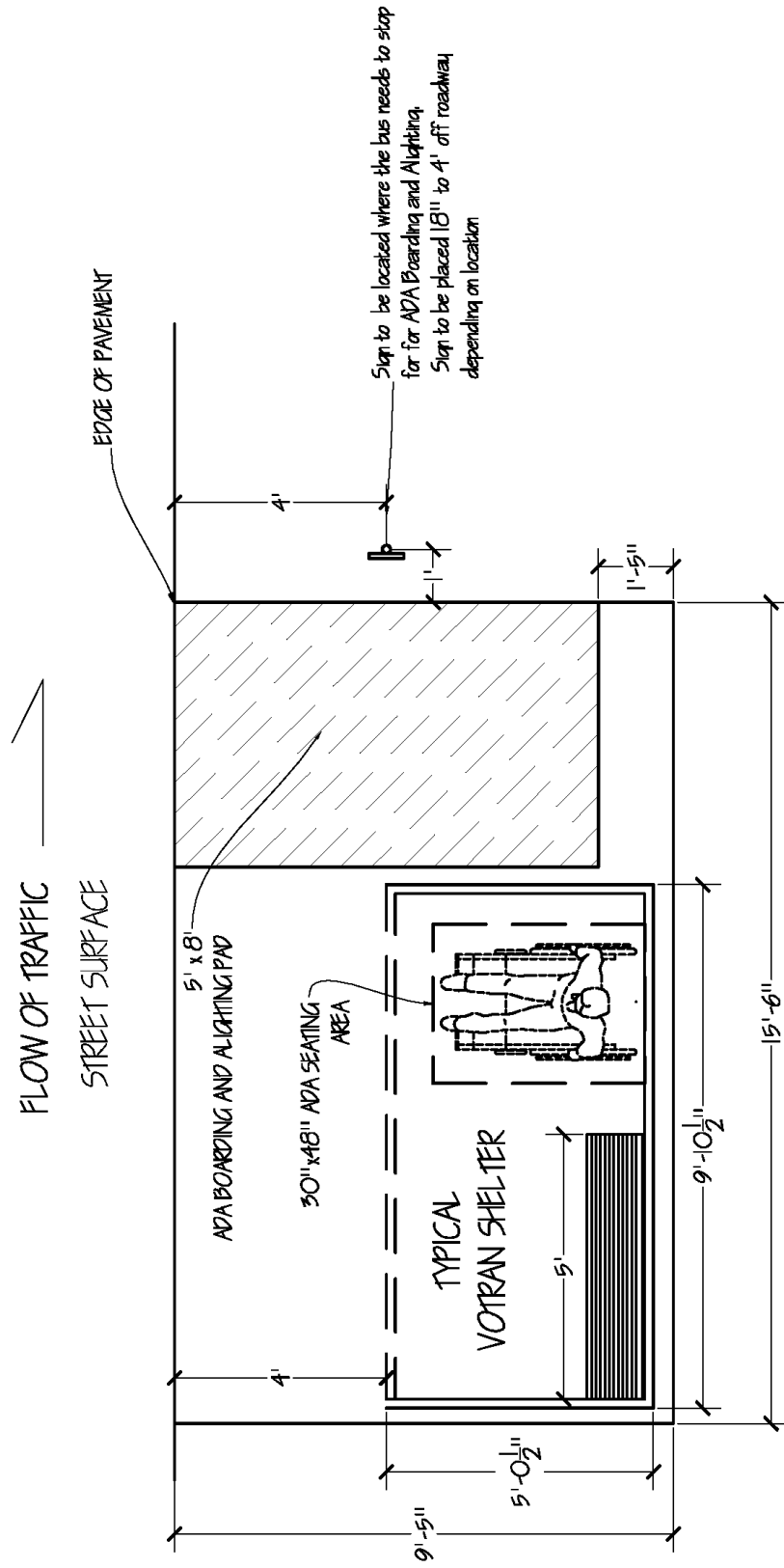

2.14 Bus Bench Pad w/ Curb, w/ Sidewalk, w/ Bike Rack

2.0 BUS STOP DESIGN PROTOTYPES

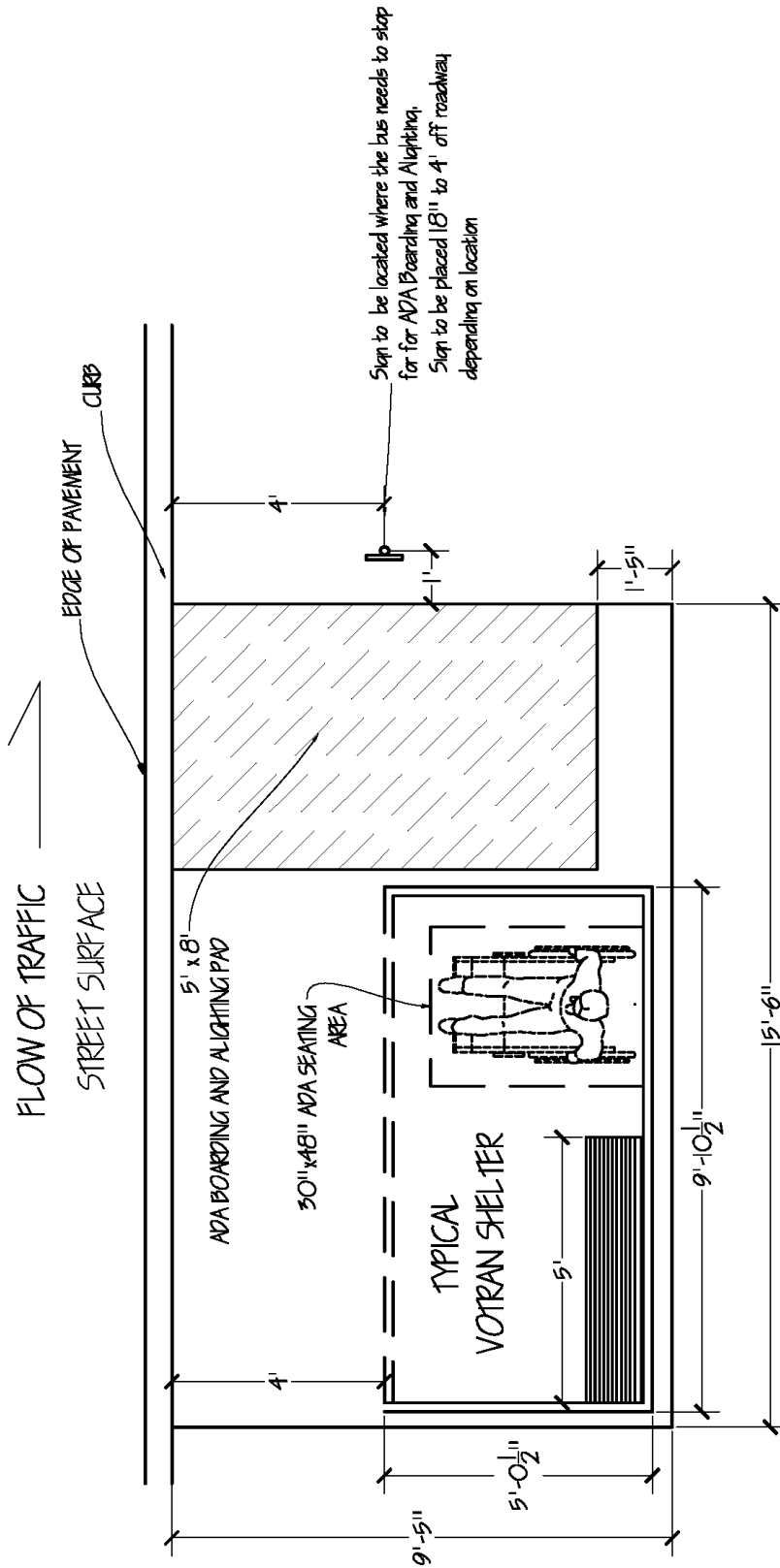

2.15 Shelter Pad w/ Curb, w/o Sidewalk

2.0 BUS STOP DESIGN PROTOTYPES

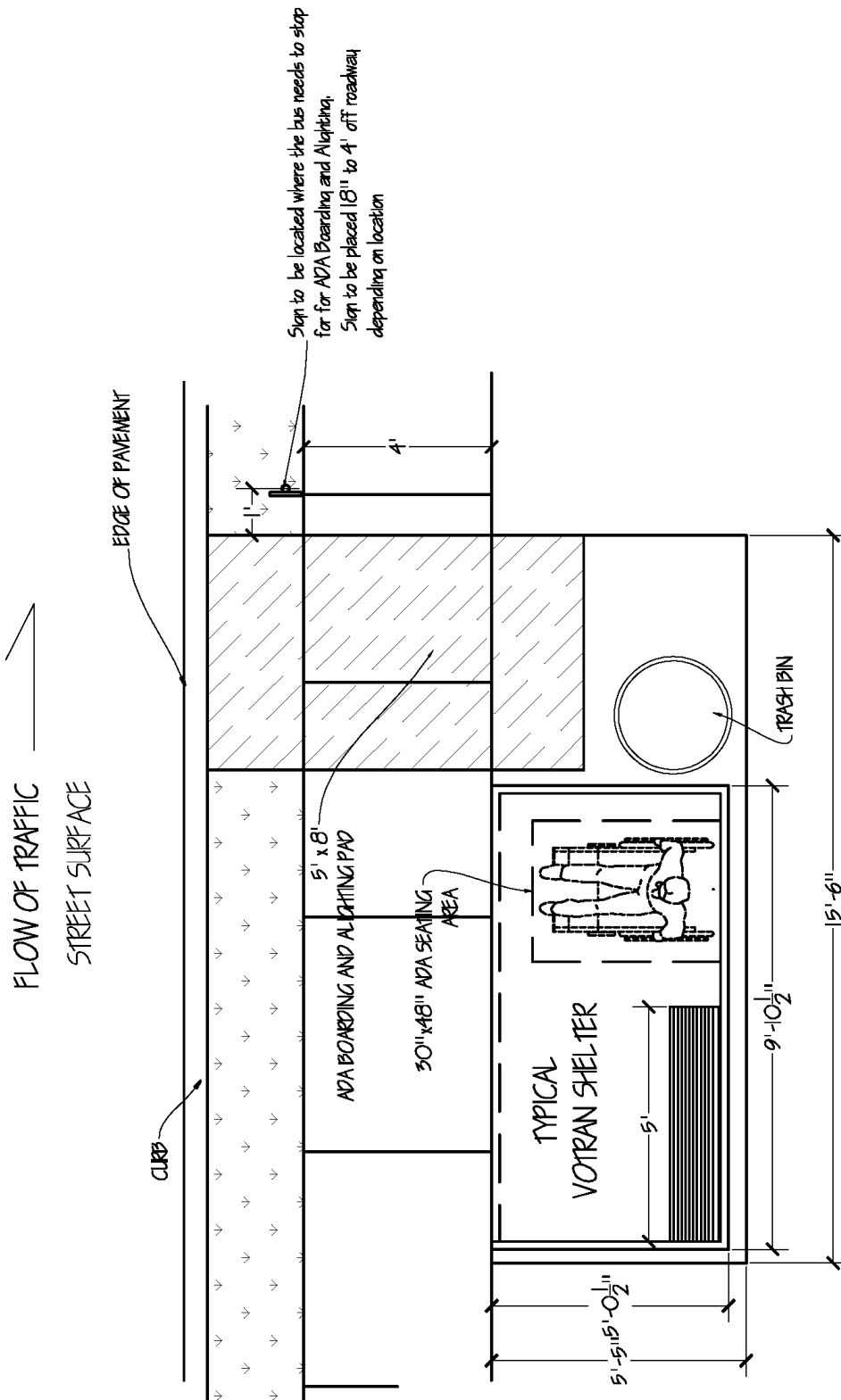

2.16 Shelter Pad w/ Curb, w/ Sidewalk

2.0 BUS STOP DESIGN PROTOTYPES

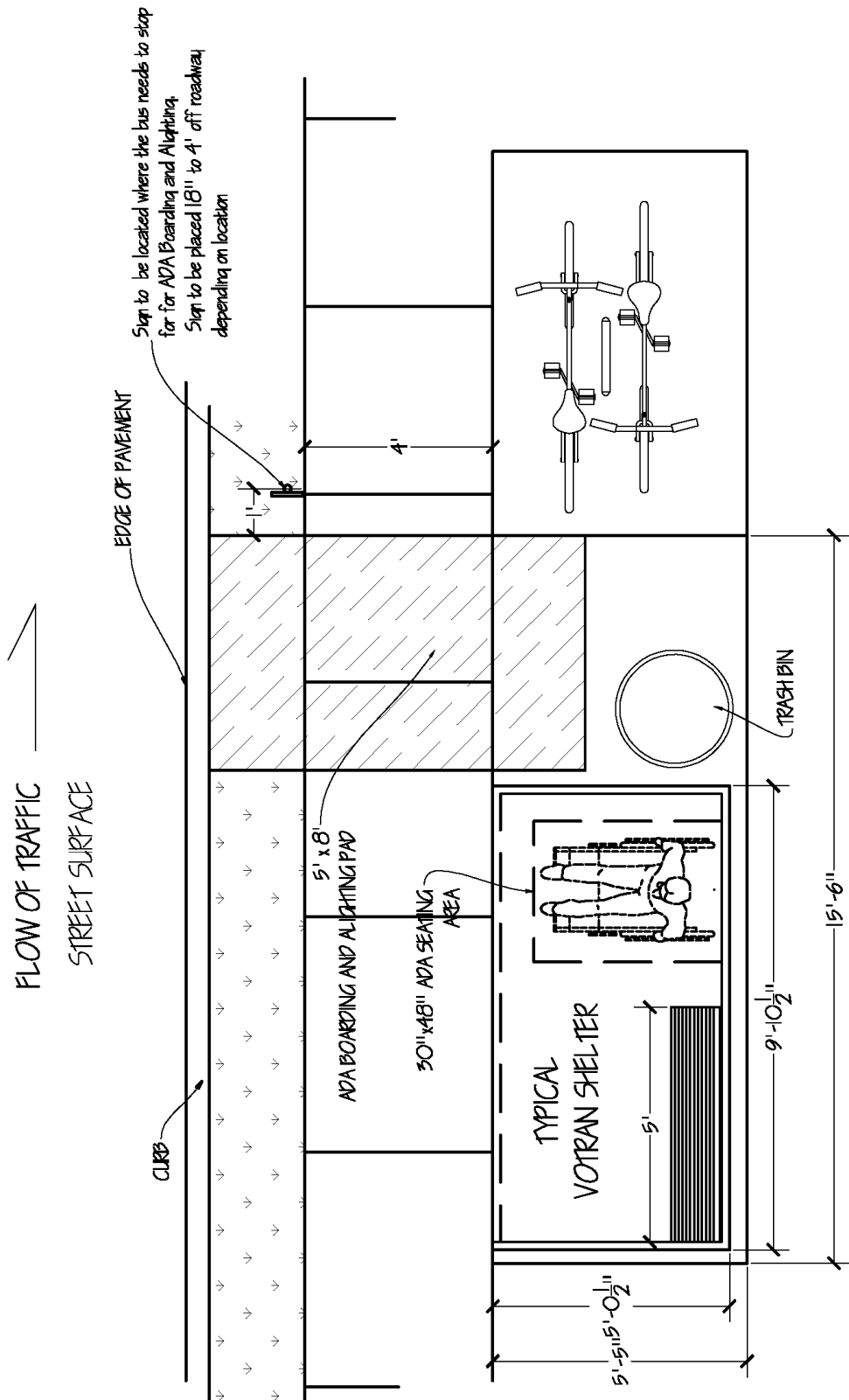

2.17 Shelter Pad w/ Curb, w/ Sidewalk, w/ Bike Rack

3.0 GENERAL ACCESSIBILITY GUIDELINES

3.1 ELEMENTS OF AN ACCESSIBLE ENVIRONMENT

Bus stops should be designed to make transit more convenient, accessible, and aesthetically appealing to transit users. These measures are necessary if public transportation is to compete effectively with other transportation modes. The proper design of bus stop zones and adjacent curbs can increase transit access and convenience by eliminating barriers, especially for those individuals with mobility limitations. The ADA mandates equal access to mass transit for every U.S. citizen, thereby requiring every new bus and bus stop to be wheelchair accessible to the maximum extent practicable. All elements, including benches, placed at or near bus stops for use by the public in conjunction with use of the transit system must also be fully compliant with the ADA provisions as adopted by the U.S. Department of Transportation.

Regulatory Requirements for Accessible Transportation Facilities are provided by the Federal and State governments. The ADAAG includes the Federal regulations governing accessible transportation facilities and is enforced by the U.S. Department of Transportation. The ADAAG provides the architectural specifics for the construction of new and alteration of existing transportation facilities.

The Florida State regulatory requirements are provided under the Florida Building Code, Chapter 11 Florida Accessibility Code (FAC) for Building Construction. The Florida Accessibility Code generally mirrors the requirements of the ADAAG, but is somewhat more stringent in some areas such as accessible parking spaces and accessible restroom configurations.

The following information provides a general overview of the accessibility regulations requirements for bus stops and facilities that may affect the accessibility to or use of a bus stop and amenities placed at the bus stop. Not all of the ADAAG requirements are given here. Only those pertinent for the understanding of personnel responsible for bus stop siting and placement of amenities in an accessible manner are listed.

- **Accessible Pedestrian Routes**

- ◇ Must be 36" minimum width, continuous, and unobstructed path (note that the 2012 Florida Accessibility Code requires a 48" clear accessible pathway which can be reduced to no less than 36" when approved by the Engineer).
- ◇ Must have a 32" minimum width at doorways.
- ◇ Must have 60" X 60" passing spaces at 200' intervals (if <60" wide).
- ◇ Running slope (direction of travel) must be equal to or less than 5 percent (1:20) (>5% = ramp / ramp slope cannot exceed 8.33%).
- ◇ Cross slope (perpendicular to direction of travel) must be equal to or less than 2 percent (1:48).

3.0 GENERAL ACCESSIBILITY GUIDELINES

- **Surfaces and Sidewalks**
 - ◇ Surface must be firm, stable, and slip resistant (wet or dry).
 - ◇ Changes in level between 1/4" and 1/2" must be beveled at 1:2 slope.
 - ◇ Changes in level greater than 1/2" are not allowed or must be ramped.
 - ◇ Gaps in gratings within the accessible pathway must be no greater than 1/2" wide and openings must be aligned perpendicular to travel.
 - ◇ The maximum walkway cross slope permitted is 1:48 (2%).
- **Protruding Objects**
 - ◇ Objects at 27" to 80" above grade must not be more than a 4" protrusion.
 - ◇ Post or column-mounted objects must not be more than a 12" protrusion.
 - ◇ Overhead clearance must be equal to or greater than 80" above the surface.
- **Curb Ramps**
 - ◇ The maximum ramp running slope permitted is 1:12 (8.33%).
 - ◇ The maximum ramp cross slope permitted is 1:48 (2%).
 - ◇ Side flare (transition) slopes must be no greater than 1:12 (8.33%).
 - ◇ Curb ramps must be 48" wide (FDOT Design Standards, Index 304 - width may be reduced to 36" as required by ADAAG in restricted conditions and as approved by the Engineer).
 - ◇ Curb ramps must have detectable warning material the full width of ramp and 24" from back edge of curb.
 - ◇ Curb ramps must have a 48" long landing at top of slope (FDOT Design Standards, Index 304).
 - ◇ Curb ramps must have detectable warning in truncated domes with pattern and characteristics defined by regulations, including contrasting color.
 - ◇ Detectable warning also required at landings and flush transitions at street crossings.
- **Bus Stops**
 - ◇ Must be on or connect to an accessible route.
 - ◇ Must have an accessible approach to the boarding and alighting area and all provided amenities.

3.0 GENERAL ACCESSIBILITY GUIDELINES

- ◇ The clear space of the boarding and alighting area must be equal to or no less than 60" parallel and 96" perpendicular to the curb or street/roadway edge and be connected to the accessible route.
- ◇ Slope of the boarding and alighting area perpendicular to the curb must be equal to or less than 1:48 (2%).
- ◇ The slope parallel to the curb of the boarding and alighting area should match the slope of the roadway.
- ◇ The boarding and alighting area must provide a firm, stable, and slip resistant surface.
- ◇ The bus stop site must be chosen to provide the greatest degree of accessibility practicable.
- ◇ If provided, the boarding and alighting area concrete pad must be located within the specified clear zone for the roadway environment being used according to FDOT Design Standards, Index Number 700.

Index 700 states that, "The roadside clear zone is that area outside the traveled way available for use by errant vehicles. Vehicles frequently leave the traveled way during avoidance maneuvers, due to loss of control by the driver (e.g., falling asleep) or due to collisions with other vehicles. The primary function of the clear zone is to allow space and time for the driver to retain control of his vehicle and avoid or reduce the consequences of collision with roadside objects. This area also serves as an emergency refuge location for disabled vehicles."

- ◇ Bus stop amenities must be connected to the accessible route and allow accessible maneuvering space and be within 48" maximum reach range of all operating controls (FDOT requires a 42" reach range limit for pedestrian signal control buttons).
- ◇ If a shelter is provided, it must connect to the accessible route and allow a minimum space of 30" X 48" fully within shelter.
- ◇ If a bench is included within a shelter, it must allow minimum space of 30" X 48" resting/transfer space at one end of bench.

3.0 GENERAL ACCESSIBILITY GUIDELINES

3.2 SPECIFIC ADAAG REQUIREMENTS FOR BUS STOPS & FACILITIES

ADAAG Section 810—Requirements for Bus Stops

The following excerpt from the revised ADAAG (2004 published version adopted by the USDOT on November 29, 2006) provides the following specific requirements for bus stops.

810 Transportation Facilities

810.1 General. Transportation facilities shall comply with 810.

810.2 Bus Boarding and Alighting Areas. Bus boarding and alighting areas shall comply with 810.2.

Advisory 810.2 Bus Boarding and Alighting Areas. At bus stops where a shelter is provided, the bus stop pad can be located either within or outside of the shelter.

810.2.1 Surface. Bus stop boarding and alighting areas shall have a firm, stable surface.

810.2.2 Dimensions. Bus stop boarding and alighting areas shall provide a clear length of 96 inches (2,440 mm) minimum, measured perpendicular to the curb or vehicle roadway edge, and a clear width of 60 inches (1,525 mm) minimum, measured parallel to the vehicle roadway.

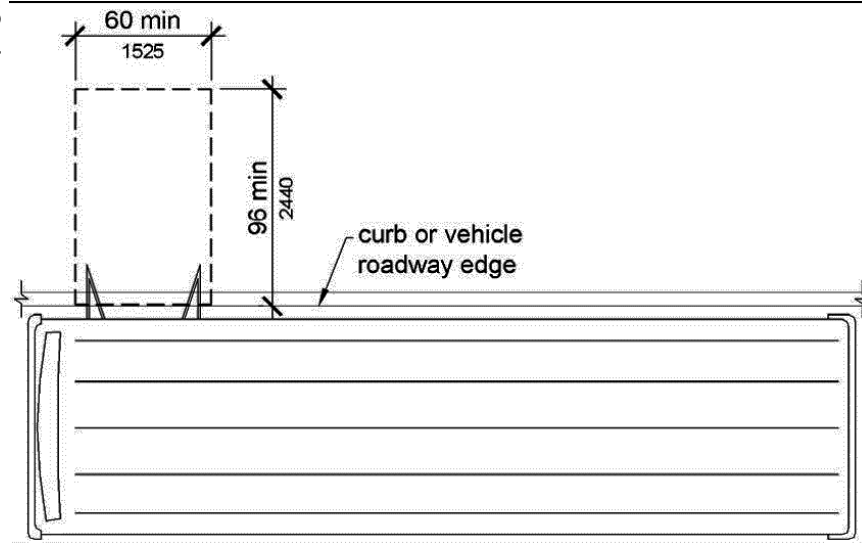

Figure 3.2.1
Dimensions of Bus Boarding and Alighting Areas
(Adapted from ADAAG Figure 810.2.2)

810.2.3 Connection. Bus stop boarding and alighting areas shall be connected to streets, sidewalks, or pedestrian paths by an accessible route complying with 402.

3.0 GENERAL ACCESSIBILITY GUIDELINES

810.2.4 Slope. Parallel to the roadway, the slope of the bus stop boarding and alighting area shall be the same as the roadway, to the maximum extent practicable. Perpendicular to the roadway, the slope of the bus stop boarding and alighting area shall not be steeper than 1:48.

810.3 Bus Shelters. Bus shelters shall provide a minimum clear floor or ground space complying with 305 entirely within the shelter. Bus shelters shall be connected by an accessible route complying with 402 to a boarding and alighting area complying with 810.2.

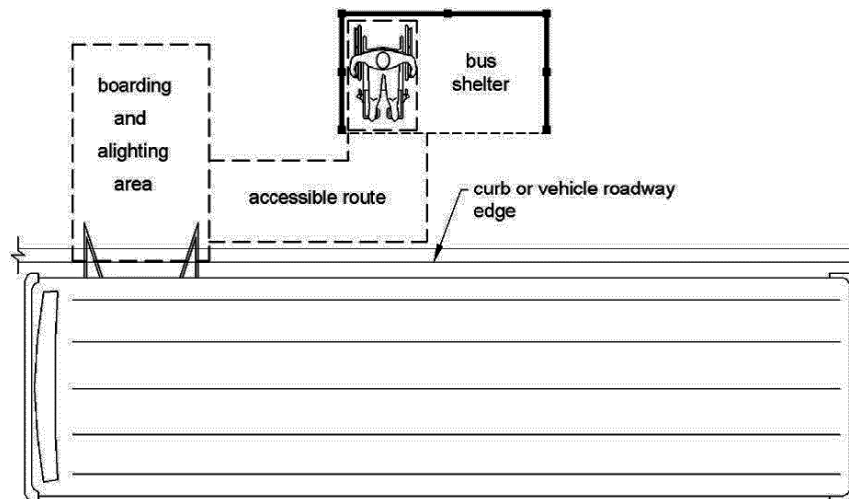

**Figure 3.2.2
Bus Shelters
(Adapted from ADAAG Figure 810.3)**

810.4 Bus Signs. Bus route identification signs shall comply with 703.5.1 through 703.5.4, and 703.5.7 and 703.5.8. In addition, to the maximum extent practicable, bus route identification signs shall comply with 703.5.5. These requirements include specifications for contrast, character height and spacing, style, etc.

EXCEPTION: Bus schedules, timetables, and maps that are posted at the bus stop or bus bay shall not be required to comply.

Figure 3.2.3 on the following page illustrates the dimensional characteristics of an accessible bus stop. Note that placement of a bench or other item at the transit site must be as an attached amenity and placed in a manner to ensure that those clear areas provided for accessibility are not obstructed.

3.0 GENERAL ACCESSIBILITY GUIDELINES

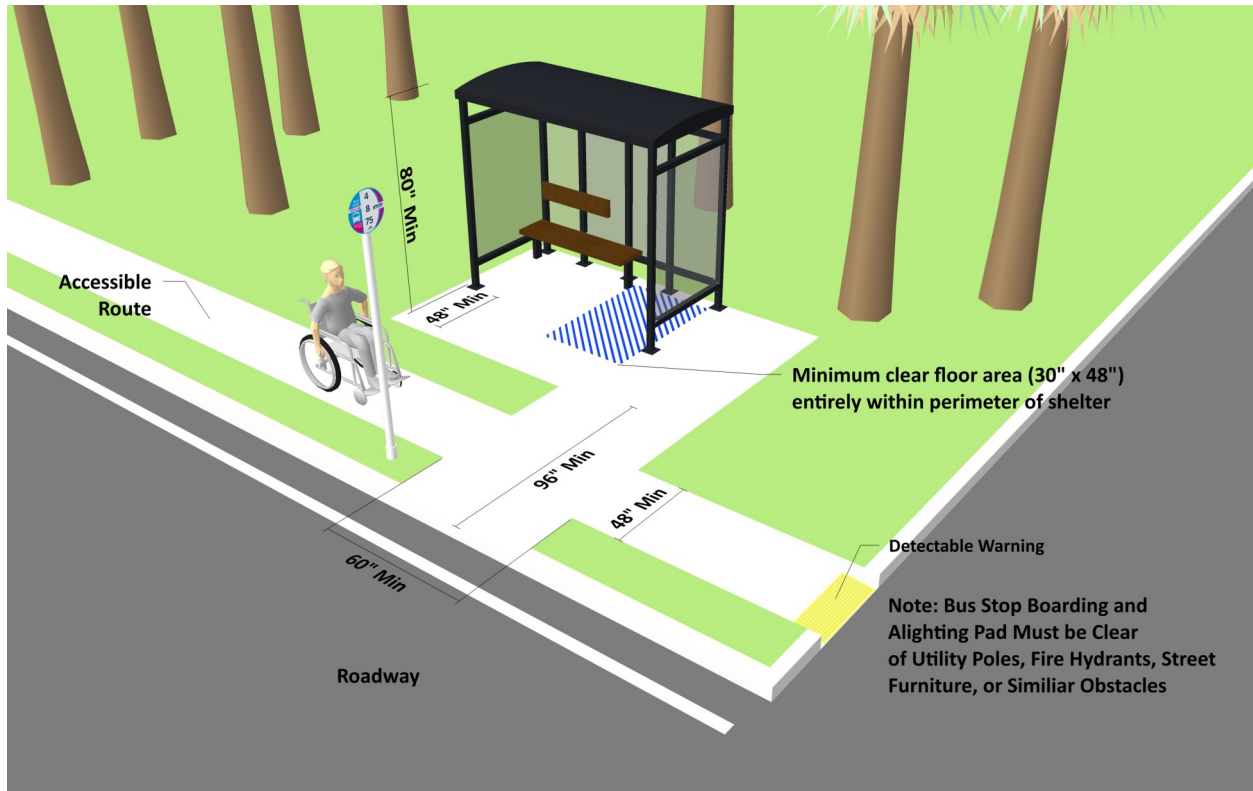

FIGURE 3.2.3 General Bus Stop Site Design Characteristics

4.0 RESEARCH & FINDINGS

4.1 CODE APPLICABILITY DISCUSSION FOR BENCH PLACEMENT AT BUS STOPS

The ADAAG contains specific requirements for benches in Section 903. However, the scoping provisions of the ADAAG indicate that Section 903 is only applicable to benches located in interior spaces such as dressing, fitting, and locker rooms (803.4), and in holding and housing cells (807.2.2).

Additionally, to reinforce agreement of the above comment, it is necessary to note that according to direct communication with U.S. Access Board technical staff, ADAAG Section 903 is not applicable to benches placed in the public right-of-way. However, the Public Rights-of-Way Accessibility Guidelines published by the Access Board (PROWAG are not enforceable regulations at the time of this writing) do specify accessibility guidelines for benches in the public right-of-way. PROWAG particularly emphasizes the need to consider the dimensions and use of pedestrian circulation routes when coordinating the placement of improvements, appurtenances, utilities, or street furniture (including benches). Comments from disability organizations and individuals have identified blocked or compromised pedestrian routes as a major barrier to independent travel.

FDOT has taken an aggressive posture concerning the placement of benches and other amenities within the public right-of-way, particularly at transit stops. Rule 14-20.0032, Placement of Transit Bus Benches, specifically addresses requirements for benches placed in the public right-of-way. This rule utilizes many of the requirements of ADAAG Section 903 and PROWAG R212.6 covering the placement and dimensional characteristics for benches. This Votran Bus Stop Design standards document has been developed to incorporate the FDOT (PROWAG) and ADAAG requirements for benches and the applicable requirements are included on the following pages.

4.0 RESEARCH & FINDINGS

4.2 ADAAG SECTION 903 REQUIREMENTS

ADAAG SECTION 903

903 Benches

903.1 General. Benches shall comply with 903.

903.2 Clear Floor or Ground Space. Clear floor or ground space complying with 305 shall be provided and shall be positioned at the end of the bench seat and parallel to the short axis of the bench.

903.3 Size. Benches shall have seats that are 42 inches (1065 mm) long minimum and 20 inches (510 mm) deep minimum and 24 inches (610 mm) deep maximum.

903.4 Back Support. The bench shall provide for back support or shall be affixed to a wall. Back support shall be 42 inches (1065 mm) long minimum and shall extend from a point 2 inches (51 mm) maximum above the seat surface to a point 18 inches (455 mm) minimum above the seat surface. Back support shall be 2½ inches (64 mm) maximum from the rear edge of the seat measured horizontally.

903.5 Height. The top of the bench seat surface shall be 17 inches (430 mm) minimum and 19 inches (485 mm) maximum above the finish floor or ground.

903.6 Structural Strength. Allowable stresses shall not be exceeded for materials used when a vertical or horizontal force of 250 pounds (1112 N) is applied at any point on the seat, fastener, mounting device, or supporting structure.

903.7 Wet Locations. Where installed in wet locations, the surface of the seat shall be slip resistant and shall not accumulate water.

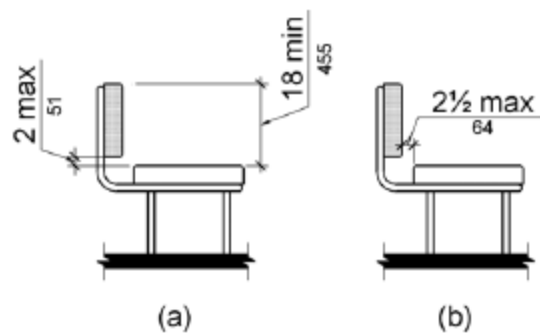

Figure 4.2.1
ADAAG Figure 903.4 Bench Back Support

4.0 RESEARCH & FINDINGS

4.3 PUBLIC RIGHTS-OF-WAY ACCESSIBILITY GUIDELINES

The specific PROWAG guidelines relevant to accessible placement of benches follows. As of this writing, these guidelines are not enforceable requirements. A public review and comment period and a Notice of Proposed Rule Making are pending for the adoption and enforcement of the PROWAG.

R211 Street Furniture

Street furniture intended for use by pedestrians and installed on or adjacent to a pedestrian circulation path shall comply with R307.

Advisory R211 Street Furniture. This scoping applies usability and operability criteria to certain items intended for pedestrian use in the public right-of-way. Where multiple items of a single type are provided at a single location, only a proportion may be required to be accessible and to be located on a pedestrian access route. Types of street furniture for which usability and operational criteria are provided include elements such as drinking fountains; public telephones; public toilet facilities; and tables, counters, and benches in R211; parking meters in R308.6; bus stops and shelters in R212; and signage, including bus stop signage, in R210. Where applicable, usability and operability provisions shall be satisfied in the design and construction of other items installed on or along a public right-of-way for pedestrian use (see sections R307, R401, and R405).

Careful coordination is required between agencies and divisions authorized to install items on and along sidewalks in order to avoid inadvertent conditions that may constitute barriers. The U.S. Department of Justice ADA regulations required that the usability of accessible features be maintained (28 CFR §35.133 and §36.211).

R212 Bus Stops

Where provided, bus boarding and alighting areas shall comply with R410. Where provided, bus shelters shall comply with R410.2.

Advisory R212 Bus Stops. Where bus stops are marked along existing streets by the placement of signage, benches, or shelters, other features necessary to accessibility, such as surface improvements and curb ramps, will be subject to the program access requirements of the U.S. Department of Justice title II regulation at 28 CFR 35.151 or the U.S. Department of Transportation 504 regulation at 49 CFR Part 27. Transportation, public works, and transit agencies should consider including needed improvements in their transition plans and other program accessibility planning.

Furthermore, the placement of such items is subject to usability and protruding objects provisions that apply to street furniture. Bus stop benches and shelters shall not intrude into an existing pedestrian access route.

4.0 RESEARCH & FINDINGS

R307 Street Furniture

R307.1 General. Street furniture shall comply with R307.

Advisory R307.1 General. Elements are often placed on a sidewalk without coordination by different agencies or entities. Covered entities must ensure that the usability of the pedestrian access route is maintained.

Where items are added to an existing developed streetscape and the pedestrian walkway is not being replaced or altered within the scope of the project, locations should be carefully selected for minimum slope and cross slope and adequate width and maneuvering space to optimize usability.

R307.2 Clear Floor or Ground Space. Street furniture shall have clear space complying with R402 and shall be connected to the pedestrian access route.

R307.6 Tables, Counters, and Benches. Tables, counters, and benches shall comply with R307.6.

R307.6.3 Benches.

R307.6.3.1 Clear Space for Wheelchairs at Benches. Where benches without tables are provided at a single location, at least 50 percent, but no fewer than one*, shall provide clear space complying with R402 [30" X 48"] positioned at the end of the bench seat and located for shoulder-to-shoulder seating.

**This statement refers to a single seat position.*

R307.6.3.2 Benches. Where benches without tables are provided at a single location, at least 50 percent, but no fewer than one, shall have a seat height at the front edge of 43 cm (17 in) minimum and 49 cm (19 in) maximum above the ground or floor space.

Advisory R307.6.3.2 Benches. Benches will be most useful if they have full back support and armrests to assist in sitting and standing.

4.0 RESEARCH & FINDINGS

4.4 FLORIDA ACCESSIBILITY CODE: PLACEMENT OF TRANSIT BUS BENCHES

The requirements of the Florida Accessibility Code are generally in concert with the Public Rights-of-Way Accessibility Guidelines and the ADAAG accessibility requirements. The following provides the text of Florida Administrative Code (FDOT) Rule 14-20.0032 *Placement of Transit Bus Benches*. Note that the upcoming revision of the FDOT Accessing Transit handbook will likely include requirements that are not currently included in Rule 14-20. Additionally, FDOT's ADA Coordinator has stated that an update to Rule 14-20 is also likely in the near future.

The Department allows placement and maintenance of transit bus benches on the right-of-way of a Federal-Aid highway or state highway pursuant to written approval by the appropriate city or county government within whose jurisdiction the bench is to be located. All bus benches shall be subject to the following:

- (1) Transit bus benches placed on the right-of-way shall not exceed 74 inches in length, 28 inches in depth, and 44 inches in height.
- (2) Any bench placed on any part of a sidewalk shall leave at least three feet clearance for pedestrian traffic between the bench and the nearest edge of the road.
- (3) Transit bus benches shall not be placed in the median of any divided highway or on limited access facilities.
- (4) Unless otherwise herein provided, transit bus benches shall be placed only at recognized transit stops. However, only the minimum number of benches necessary to accommodate the comfort and convenience of the general public shall be erected or maintained.
- (5) Benches may be placed at points of pedestrian convenience other than recognized transit bus stops, where, in the judgment of the appropriate city or county government, there exists a necessity for such seating or where such seating would otherwise serve the public interest and shall comply with all other requirements placed upon transit bus benches in Rule 14-20.0032, FAC. However, only the minimum number of benches necessary to accommodate the comfort and convenience of the general public shall be erected or maintained.
- (6) If the Department finds any bench in violation of any portion of this rule, except those determined to endanger life or property, the Department shall provide written notice of the violation to the owner of the bench, or the appropriate city or county government, who shall correct the violation or remove the shelter within 30 days after receipt of the notice. If the Department finds any bench to be a danger to life or property, the Department shall provide notice to the owner of the bench, or the appropriate city or county government, who shall take immediate steps to make the bench safe or remove the bench. If the condition or location of a bench is not corrected in accordance with the Department's notice, the Department will cause the bench to be removed and seek the cost of removal from the owner of the bench.
- (7) Commercial advertising shall be displayed upon a transit bus bench only on either the front or rear surface of the backrest area.
- (8) Advertising displayed on a transit bus bench shall not be greater than 72 inches in length

4.0 RESEARCH & FINDINGS

nor greater than 24 inches in height, and no advertising displayed upon a bench shall be of a reflectorized material.

- (9) The transit bus bench location must meet the set back and minimum clear recovery zone requirements as detailed in the Florida Department of Transportation's *Roadway and Traffic Design Standards*, Index Number 700, entitled "Design Criteria Related to Highway Safety" (incorporated by reference in Rule 14-85.004, Florida Administrative Code).
- (10) Any transit bus bench that was in service prior to April 1, 1992, may be replaced with a bus bench of the same size or smaller, if the bench is damaged or destroyed or otherwise becomes unusable.
- (11) Any transit bus bench placed at points of public convenience which violates any portion of this rule shall be subject to removal upon 30 days notice if the violation is not corrected.
- (12) Whenever necessary for the construction, repair, improvement, maintenance, safe and efficient operation, alteration, or relocation of all, or any portion of a State Road, as determined by the Department, any bus bench and appurtenances thereto, authorized by this Rule, shall be immediately removed from said State Road Right-of-Way or shall be reset or relocated thereon as required by the Department, at the expense of the bench owner unless reimbursement is authorized by separate agreement. In the event the relocation of said benches is scheduled to be done simultaneously with the Department's construction work, the bench owner shall coordinate with the Department before proceeding. The bench owner shall cooperate with the Department's contractor to arrange the sequence of work so as not to delay the work of the Department's contractor and shall defend any legal claims of the Department's contractor due to delays caused by the bench owner's failure to comply with the approved schedule. The bench owner shall not be responsible for delays for reasons beyond the bench owner's reasonable control.

Specific Authority 334.044(2) FS. Law Implemented 334.044(13), 335.021(1), 337.408 FS. History—New 12-26-90, Amended 8-11-92, 5-15-97, 7-16-98.

5.0 DEFINITIONS & ACRONYM LIST

ACCESSIBLE - A site, building, facility, or portion thereof that is in compliance with the ADAAG provisions and regulations.

ACCESSIBILITY - A measure of the ability or ease of all people to access a given area or system.

ACCESSIBLE MEANS OF EGRESS - A continuous and unobstructed way of egress travel from any point in a building or facility that provides an accessible route to an exit or a public way.

ADA - The Americans with Disabilities Act of 1990, which includes the final rule, which sets forth the transportation standards contained in 49 CFR Parts 27, 37, and 38.

ADAAG - The appendix to the 49 CFR Part 37 containing the Americans with Disabilities Act Accessibility Guidelines for Buildings and Facilities, which provides the architectural and structural requirements for an accessible environment.

ALTERATION - A change to a building or facility that affects or could affect the usability of the building or facility or portion thereof. Alterations include, but are not limited to, remodeling, renovation, rehabilitation, reconstruction, historic restoration, resurfacing of circulation paths or vehicular ways, changes or rearrangement of the structural parts or elements, and changes or rearrangement in the plan configuration of walls and full-height partitions. Normal maintenance, reproofing, painting or wallpapering, or changes to mechanical and electrical systems are not alterations unless they affect the usability of the building or facility.

BOARDING AND ALIGHTING AREA - The clear space at a bus stop allocated for patrons to board or alight from the bus.

BUILDING - Any structure used or intended for supporting or sheltering any use or occupancy.

BUS BAY - A widened portion of the roadway or right-of-way that permits buses or special use vehicles to stop outside of the traffic through lanes while passengers board or alight the bus or special use vehicle. It is designed to allow easy reentry of the bus or special use vehicle into the traffic stream.

5.0 DEFINITIONS & ACRONYM LIST

BUS STOP - A designated area where local buses stop to load and unload passengers along local or express routes. The bus stop is the passenger interface and bus operating area. The ADA considers a bus stop a “transportation facility” and is governed by the USDOT ADA regulations.

CIRCULATION PATH - An exterior or interior way of passage provided for pedestrian travel, including, but not limited to, walks, hallways, courtyards, elevators, platforms, ramps, stairways, and landings.

CLEAR ZONE - The area outside the traveled way available for use by errant vehicles. The primary function of the clear zone is to allow space and time for the driver to retain control of his vehicle and avoid or reduce the consequences of collision with roadside objects.

CONNECTION - For purposes of access management, any driveway, street, turnout, sidewalk, or other means of providing for the movement of vehicles, pedestrians, or bicycles to or from the public roadway system.

CORRIDOR - A broad geographical band that follows a general directional flow or connects major sources of trips.

CROSS SLOPE - The slope that is perpendicular to the direction of travel.

CURB RAMP - A short ramp cutting through a curb or built up to it to allow accessible travel between two elevations.

DETECTABLE WARNING - A standardized surface feature built in or applied to walking surfaces or other elements to warn of hazards on a circulation path.

ELEMENT - An architectural or mechanical component of a building, facility, space, or site.

FACILITY - All or any portion of buildings, structures, site improvements, elements, and pedestrian routes or vehicular ways located on a site.

FDOT - Florida Department of Transportation

HEADWAY - The scheduled time intervals between vehicles moving along the same route, line, or roadway in the same direction.

5.0 DEFINITIONS & ACRONYM LIST

MARKED CROSSING - A crosswalk or other identified path intended for pedestrian use in crossing a vehicular way.

MODE - A particular form of travel (i.e., walking; bicycling; travel by air, land, or sea in various purpose vehicle). More generally identifies mode of transportation within a system such as bus, rail, shuttle, etc.

PPM - Plans Preparation Manual. The PPM sets forth geometric and other design criteria, as well as procedures, for Florida Department of Transportation (FDOT) projects.

PUBLIC ROAD - Any roadway owned and/or maintained by the state, county, or city.

PUBLIC TRANSPORTATION FACILITIES - Bus stops, transit centers, park-and-ride lots, high occupancy vehicle (HOV) lanes and pullouts, multi-modal facilities, rail stations, etc.

PUBLIC USE - Interior or exterior rooms, spaces, or elements that are made available to the public. Public use may be provided at a building or facility that is privately or publicly owned.

PUBLIC WAY - Any street, alley, or other parcel of land open to the outside air leading to a public street, which has been deeded, dedicated, or otherwise permanently appropriated to the public for public use and that has a clear width and height of not less than 10 feet.

RAMP - A walking surface that has running slope steeper than 1:20 (5%).

REGULATED ROADWAY - A road segment that has an adopted level of service standard.

RIGHT-OF-WAY - A general term denoting land, property, or interest therein, usually in a strip, acquired for transportation purposes.

ROADWAY - The portion of a street or highway, including shoulders, for the intended use of vehicles.

RUNNING SLOPE - The slope that is parallel to the direction of travel.

5.0 DEFINITIONS & ACRONYM LIST

SPACE - A definable area, such as a room, toilet room, hall, assembly area, entrance, storage room, alcove, courtyard, or lobby.

TACTILE - An object that can be perceived using the sense of touch.

TECHNICALLY INFEASIBLE - With respect to an alteration of a building or a facility, something that has little likelihood of being accomplished because existing structural conditions would require removing or altering a load-bearing member that is an essential part of the structural frame; or because other existing physical or site constraints prohibit modification or addition of elements, spaces, or features that are in full and strict compliance with the minimum requirements.

TRANSFER - A passenger's change from one transit vehicle to another transit vehicle to complete the patron's travel pattern.

TRANSIT AMENITIES - Added fixtures at transit stops and facilities to provide additional comfort and conveniences for patrons (i.e., benches, kiosks, waste receptacles, telephones, shelters, etc.) (also known as "transit infrastructure").

TRANSIT STATION - A designated area where passengers may embark or disembark from rail or bus public transportation equipment.

TRANSIT STOP - A designated area where passengers may embark or disembark from rail or bus public transportation equipment.

US DOJ - United States Department of Justice

US DOT - United States Department of Transportation

VEHICLE - Every device in, upon, or by which any person or property is or may be transported or drawn upon a travel way, excepting devices used exclusively upon stationary rails or tracks.

VEHICULAR WAY - A route provided for vehicular traffic, such as in a street, driveway, or parking facility.

WALK - An exterior prepared surface for pedestrian use, including pedestrian areas such as plazas and courts.

5.0 DEFINITIONS & ACRONYM LIST

WHEELCHAIR LIFT - A device mounted on a transit vehicle used to raise and lower a platform to transport a person in a wheelchair or other mobility aid from the ground surface, sidewalk, or landing area to the interior of a transit vehicle and vice versa.

WHEELCHAIR RAMP - A device mounted on a transit vehicle and deployed to the ground surface, sidewalk, or boarding and alighting area to allow a person in a wheelchair or other mobility aid to enter or exit the transit vehicle.

WHEELCHAIR SPACE - Space for a single wheelchair and its occupant.

6.0 REFERENCES

TECHNICAL RESOURCES AND REFERENCES OF INDUSTRY STANDARDS AND BEST PRACTICES

Our appreciation for those involved in previous work on bus stop guidelines, as these were used as base information to develop the Votran Technical Design Standards for Accessible Bus Stops. Most notable of these were:

- *TCRP Report 19, Guidelines for the Location and Design of Bus Stops (1996)*

Review of content from several other agency design and standards manuals and other technical sources were considered in the development of this manual and include:

- *U.S. Access Board technical publications and published regulations and guidelines*
- *TCRP/Transit Research Board technical publications*
- *Easter Seals Project ACTION publications*
- *U.S. Department of Transportation/Federal Transit Administration technical assistance publications*
- *U.S. Department of Justice technical source documentation*
- *Florida Department of Transportation resource publications*
- *American Public Transportation Association resources*
- *Florida Administrative Code 14-20: Rules for Private Use of Right of Way*

Appendix—DESIGN STANDARDS & SCENARIOS

A.1 PRIORITY CONSIDERATIONS FOR BENCH AND SHELTER PLACEMENT AT BUS STOPS

This section describes important considerations for bench and shelter placement at bus stops. ADA standards require all bus stops to have sufficient space for a boarding and alighting area that has a firm, stable, and slip-resistant surface to accommodate boarding and alighting at the stop. When a bench or shelter is provided at a bus stop, a boarding and alighting area concrete pad is required and must be located within the specified clear zone for the roadway environment being used according to FDOT Design Standards, Index Number 700. If bus stop amenities in addition to a bus stop sign are provided, the bus stop boarding and alighting area shall be connected to the amenities, streets, sidewalks, and/or existing pedestrian infrastructure by an accessible route.

1. **Bus access characteristics (critical)** – This category involves characteristics related to the use of a particular location by a transit entity for a bus stop. For a location to be viable for application of a bus stop, requirements must be met for vertical and side clearance of the bus, turning radius of the intersection, curb lane width, parking clear zone, and presence of driveways, among other criteria. Placement of a bench at a site that does not provide an accessible environment is not recommended and may present liability issues for the transit agency.
2. **Patron accessibility characteristics (critical)** – Once it is determined that a bus is capable of safely accessing a potential bus stop location, it next must be determined whether patrons can access the location conveniently and safely. To do this, patron access to/from and use of the site must be assessed. For a location to be viable from the point of view of the transit patron, requirements must be met for the presence, width, and relative connectivity of sidewalks where applicable, the presence of an ADA boarding and alighting area (minimum 5-foot by 8-foot) enabling clearance for wheelchair lift/ramp deployment, and the presence of accessible connecting pedestrian pathways and curb ramps, among other potential considerations.
3. **Site infrastructure characteristics (non-critical)** – If buses and patrons are both able to successfully access a potential bus stop location, then the location should be suitable for the placement of a bus stop. As noted previously, the purpose of evaluating the site infrastructure characteristics is to locate the best spot for the stop within the general area of the location. In considering placement of a bench or shelter, issues that should be identified and considered in establishing the best placement at a stop within a particular location include utilities, guide wires, signage, and other potential obstructions to visibility and access; the presence of driveways and other access points to adjacent development; and the presence of parallel parking.

Appendix—DESIGN STANDARDS & SCENARIOS

4. **Safety, comfort, & security characteristics (non-critical)** – The other category of characteristics that should be used to fine-tune the decision for bench or shelter placement at a potential stop at a particular location considers issues related to safety, comfort, and security of patrons and buses. Stop placement considerations in this category include appropriate visibility for both bus operators and patrons, the presence of lighting, the presence of shade, surrounding slopes (especially if a ditch is present), and the presence of a bridge, among others. These and other potential considerations related to safety, comfort, and security at stops are important considerations when reaching a decision to place a bench or shelter at a bus stop.

Appendix—DESIGN STANDARDS & SCENARIOS

A.2 GUIDELINES FOR BENCH PLACEMENT

The following are minimum guidelines for the placement of benches at bus stops. These guidelines are written in concert with established accessibility requirements found in ADAAG and the FAC.

Wheelchair Clearance

Minimum clear width for a single wheelchair passage shall be 36 inches continuously.

Note: Clearance for new locations or locations to be adjusted should provide for 48-inch clearance to be in conformance with FDOT design standards and the 2012 FAC.

Minimum clear length of 96 inches (measured perpendicular from the curb or vehicle roadway edge) and a minimum clear width of 60 inches measured parallel to the curb or roadway (8-foot deep by 5-foot wide total space) will be provided on new construction to the maximum extent allowed by legal or site constraints for deployment of a wheelchair lift/ramp from a bus.

Minimum 60-inch clearance between bench and fire hydrants.

Minimum 30-inches by 48-inches clear area at the front edge of the bench to provide space for a wheelchair to maneuver at the bench and allow the transfer from wheelchair to bench if desired. See Exhibit 5.2.1 for suggested bus stop design layouts. There are a myriad of design layout options, and the ones shown are typical for urban, suburban, or rural environments.

Clearance between Bench and Other Bus Stop Components (Trash Cans, Shelters, and Kiosks)

Avoid placement of bench next to walls or fences. If possible, maintain 36-inch clearance in front of and behind bench. If not possible, place bench within 4 inches of wall or other structure. However, this placement **must** maintain 36 inches in front of bench for accessible path clearance.

Benches placed adjacent to shelters should allow an accessible route not less than 36 inches minimum, 48 inches preferred.

Benches may be placed within a bus shelter. A space no less than 30-inches by 48-inches at one end of the bench must be provided fully within the shelter for wheelchair parking. Most bus stop shelters are designed to include benches placed to provide for a wheelchair turning space of at least 60 inches. The space required for a wheelchair to make a 180-degree turn is a clear space of 60 inches in diameter.

Appendix—DESIGN STANDARDS & SCENARIOS

Benches should avoid proximity to boarding and alighting area of 60 inches wide by 96 inches deep so as to not obstruct access.

Sight Visibility

Transit stop furniture over 2-½ feet high should be located to provide drivers in nearby drive-ways clear visibility of the street.

Firm Stable Surfaces

Place bench on firm, stable surface that allows for surface drainage.

Desirable Placement

Wherever possible, benches should be anchored to concrete to prevent unauthorized movement.

Place bench in shaded area if possible.

Place bench outside of landscape watering areas.

Beginning on page 40, typical design scenarios are provided in Figures 5.2.2 through 5.2.6 that provide illustrations and descriptions of conditions for bench placement at bus stops. These scenarios are intended as guidance for the approach to siting a bus stop and the application of public seating found at typical sites throughout the Votran service area.

Appendix—DESIGN STANDARDS & SCENARIOS

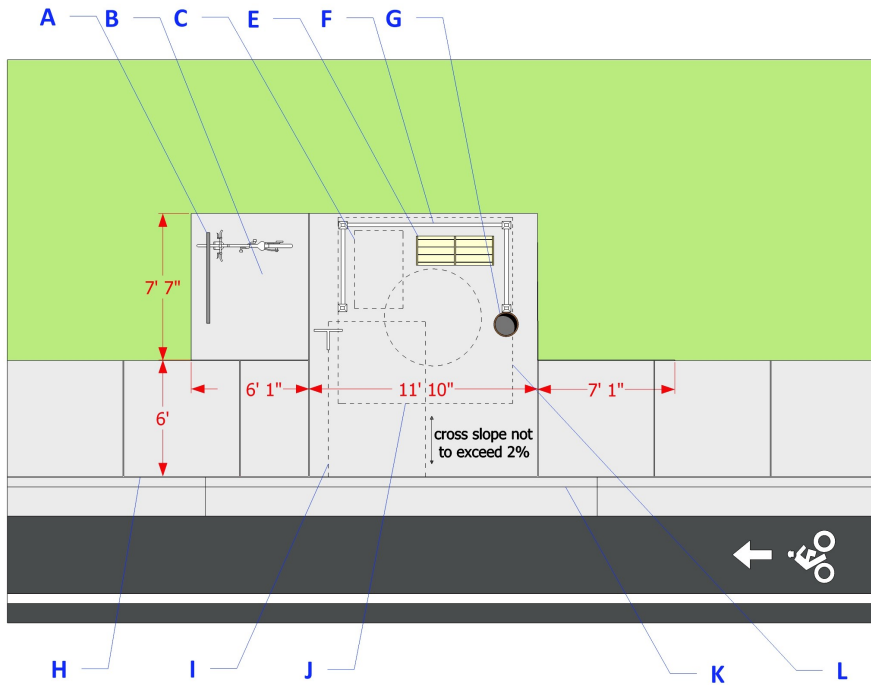

Plan View

- A: optional bike rack
- B: optional concrete pad (~56 SF)
- C: 30"X48" minimum clear area for wheelchair resting area within shelter
- E: bench within shelter
- F: bus shelter
- G: hanging trash can
- H: existing roadway curb
- I: minimum 5'X8' bus stop boarding and alighting area
- J: ~9'X9'-7" concrete bus shelter pad
- K: cross slope not to exceed 2% perpendicular to roadway edge
- L: typical 60" diameter wheelchair turning space

Plan View: Bus Stop Site at Existing Sidewalk

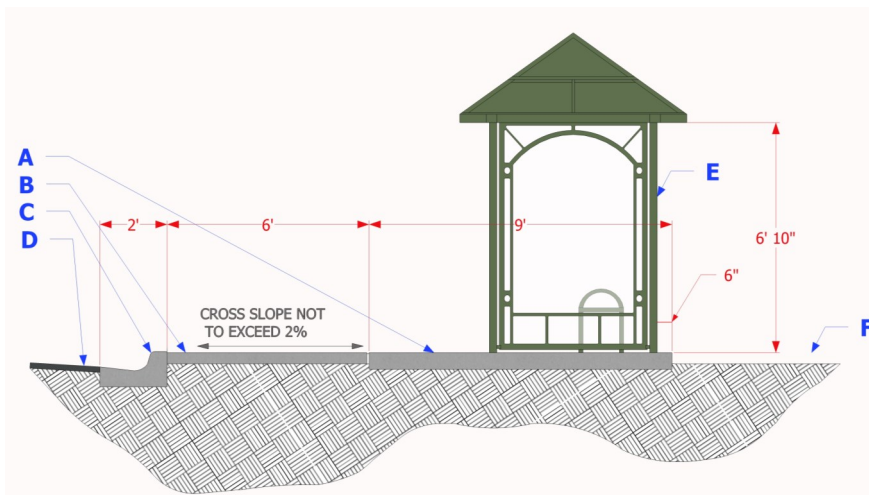

Cross Section View

- A: new concrete bus shelter pad
- B: new sidewalk
- C: new roadway curb and gutter
- D: existing asphalt
- E: new bus shelter
- F: existing grass

Cross Section View: Bus Stop Site at Existing Sidewalk

Figure A.2.1 Accessible Bus Stop Site Layout Design

Appendix—DESIGN STANDARDS & SCENARIOS

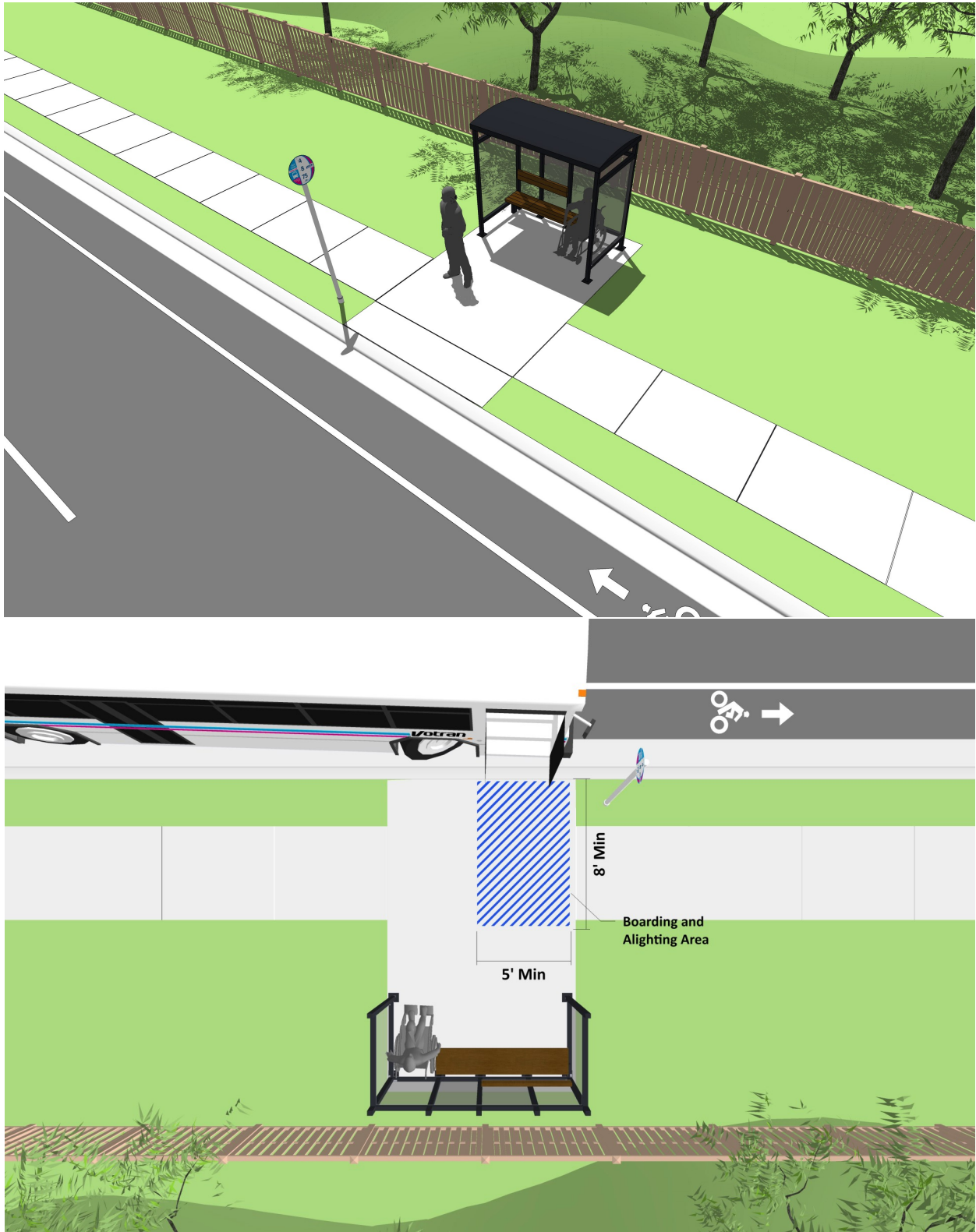

Figure A.2.1 Accessible Bus Stop Site Layout Design (continued)

Appendix—DESIGN STANDARDS & SCENARIOS

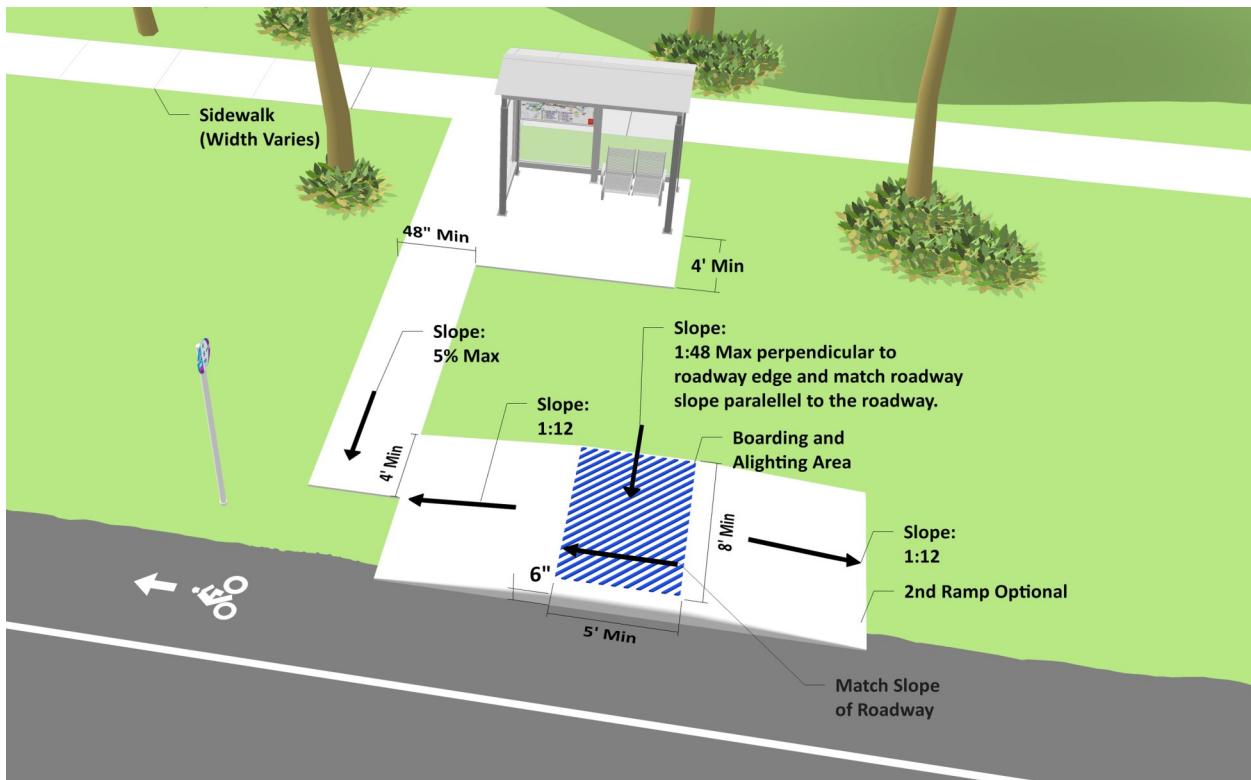
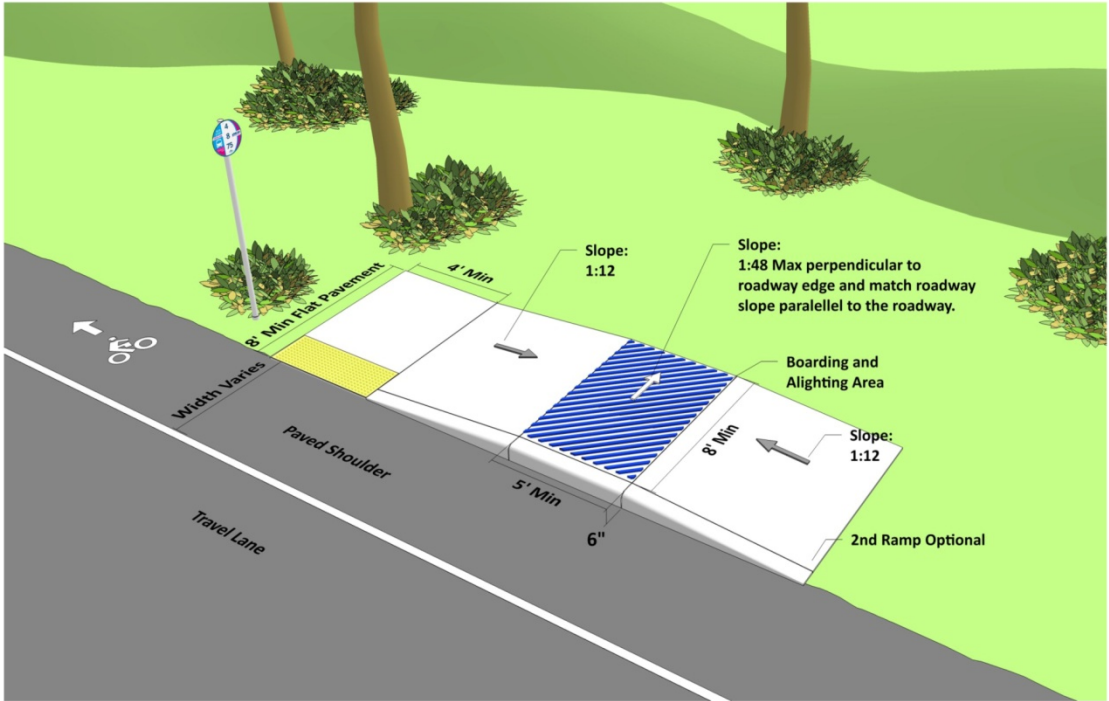
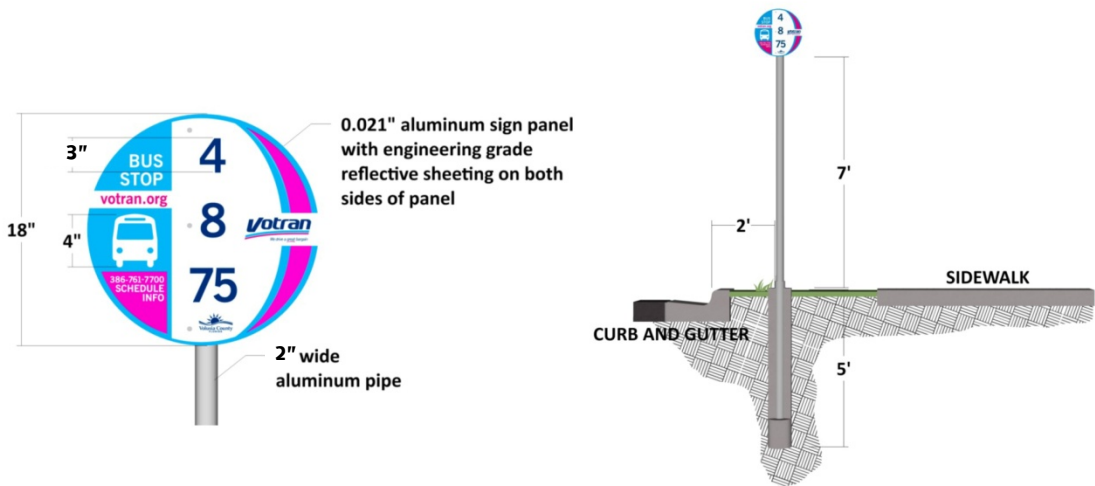

Figure A.2.1 Accessible Bus Stop Site Layout Design (continued)

Appendix—DESIGN STANDARDS & SCENARIOS



Rural Bus Stop



Bus Stop Sign Design & Placement

Figure A.2.1 Accessible Bus Stop Site Layout Design (continued)

Appendix—DESIGN STANDARDS & SCENARIOS

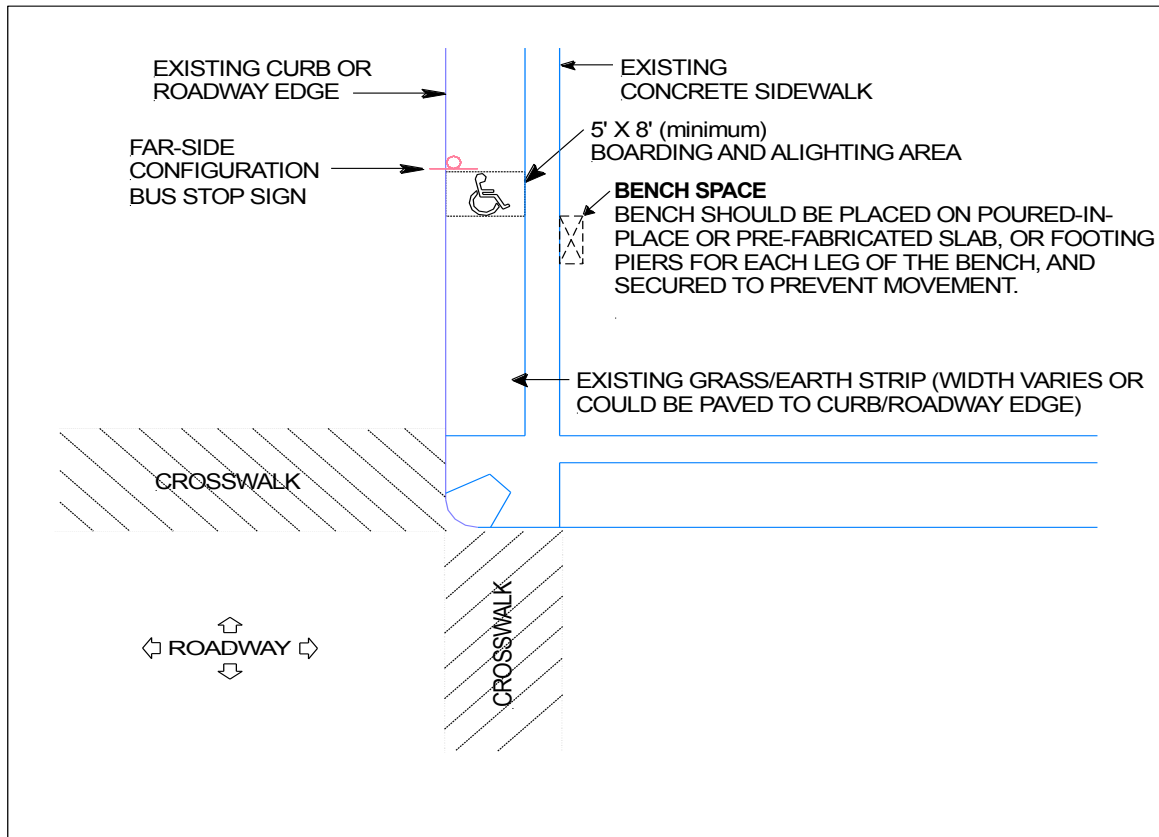

SCENARIO 1: GRASS/EARTH STRIP BETWEEN CURB/ROADWAY EDGE AND EXISTING WALKWAY

This scenario solution can be applied at urban, suburban, or rural environments.

The determination of a site for bench placement at a bus stop that affords the greatest accessibility practicable given the existing site conditions is essential. Placement of the bench must allow access by an individual using a wheelchair. A minimum 36" wide path to the bench and an area no less than 30" perpendicular and 48" parallel to the bench must be provided. The bench location must provide an unobstructed accessible path from the bus stop boarding and alighting area to the bench.

All new work, or alterations to existing sites, must be performed in compliance with ADAAG regulations by maintaining a cross slope less than 2% and running slope less than 5% except that the boarding and alighting area must coincide with slope of the roadway. Connection to existing curb/roadway edge and existing walkway must be consistent with ADAAG surface and walkway regulations by ensuring that the connection provides a smooth transition with a change in level not to exceed 1/4 inch. Walking surfaces of new work must be slip resistant - generally achieved by a broom finish to standard concrete surface.

Figure A.2.2 Bench Placement Scenario One

Appendix—DESIGN STANDARDS & SCENARIOS

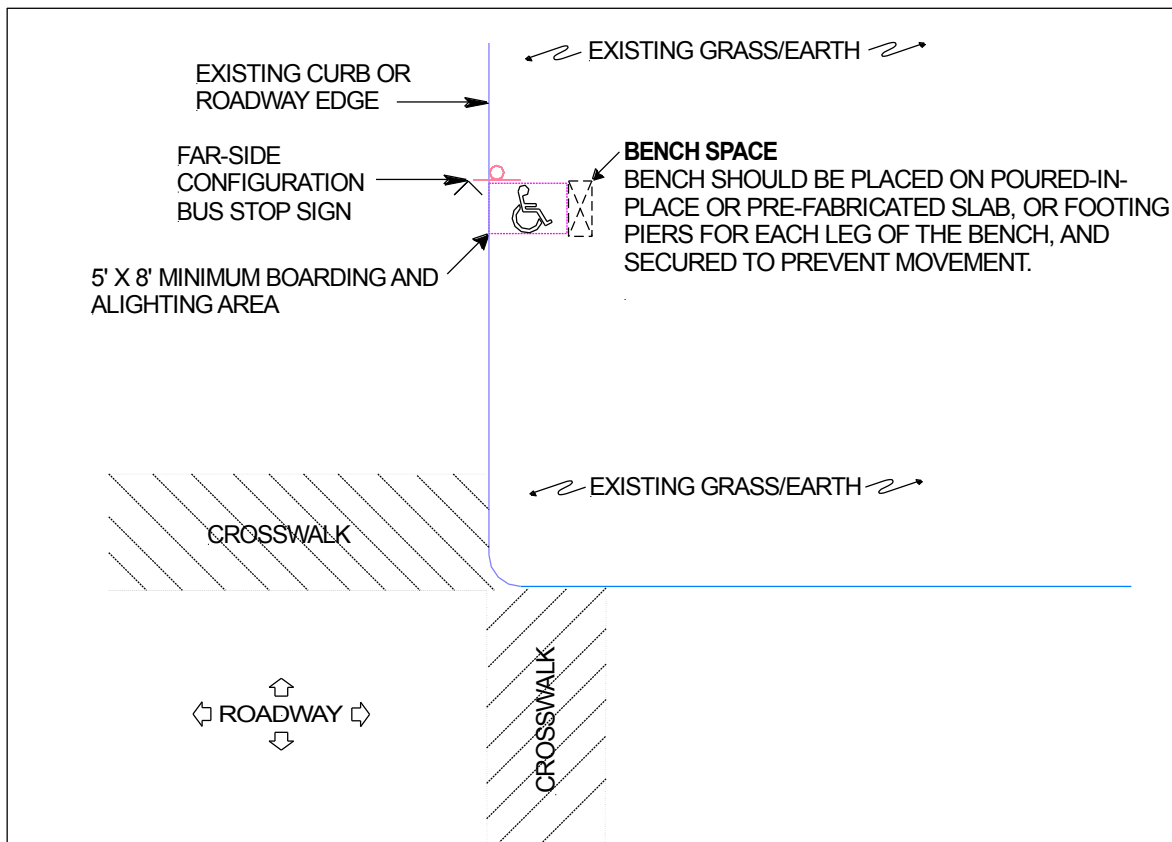

SCENARIO 2: GRASS/EARTH ALONG CURB/ROADWAY EDGE - NO EXISTING WALKWAY AT STOP WITH CONCRETE BOARDING AND ALIGHTING AREA.

This scenario solution can be applied at urban, suburban, or rural environments.

The determination of a site for bench placement at a bus stop that affords the greatest accessibility practicable given the existing site conditions is essential. Placement of the bench must allow access by an individual using a wheelchair. A minimum 36" wide path to the bench and an area no less than 30" perpendicular and 48" parallel to the bench must be provided. The bench location must provide an unobstructed accessible path from the bus stop boarding and alighting area to the bench.

All new work, or alterations to existing sites, must be performed in compliance with ADAAG regulations by maintaining a cross slope less than 2% and running slope less than 5% except that the boarding and alighting area must coincide with slope of the roadway. Connection to existing curb/roadway edge and existing walkway must be consistent with ADAAG surface and walkway regulations by ensuring that the connection provides a smooth transition with a change in level not to exceed 1/4 inch. Walking surfaces of new work must be slip resistant generally achieved by a broom finish to standard concrete surface.

Figure A.2.3 Bench Placement Scenario Two

Appendix—DESIGN STANDARDS & SCENARIOS

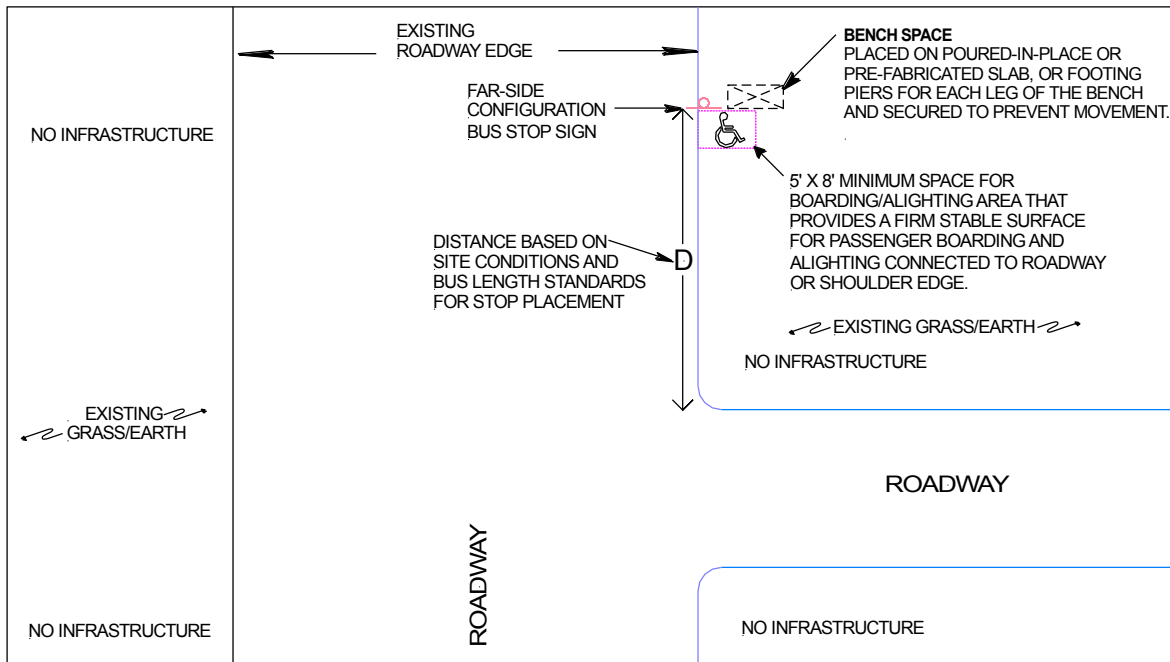

SCENARIO 3: RURAL ENVIRONMENT WITH GRASS/EARTH ALONG CURB/ROADWAY EDGE - NO EXISTING WALKWAY OR INFRASTRUCTURE AT BUS STOP SITE OR OTHER RIGHT-OF-WAY ABUTMENTS.

Transit agencies are required by the ADA to select a site for the creation of a bus stop that affords the greatest accessibility practicable given the route and site conditions.

This scenario solution can be applied at suburban or rural environments where no infrastructure exists and no pedestrian pathways have been established formally or informally. However, it is presumed that the minimum 5'-by 8'-bus stop boarding and alighting area has been established by the transit agency with a paved material.

Without infrastructure support such as walkways, curb ramps, crosswalks, pedestrian or vehicle control devices, or other forms of pedestrian rights-of-way amenities (except for the paved boarding and alighting area), passengers are at risk whenever entering into the environment described in this scenario as it is assumed that the roadway shoulder provides the pathway to and from the bus stop. However, in certain instances, particularly in undeveloped rural areas, the establishment of public transit services may serve the best interest of the community. Given this condition, bus stop sites must be selected to provide the most accessible environment possible.

Placement of a bench at sites where undeveloped and non-accessible connections to the bus stop is not provided is not recommended. However, in good faith to provide seating at these stops, placement of benches must also be accomplished in the interest of providing the most accessible placement arrangement possible. Direct connection to the paved boarding and alighting area is required to afford access to the bench by individuals with disabilities.

Figure A.2.4 Bench Placement Scenario Three

Appendix—DESIGN STANDARDS & SCENARIOS

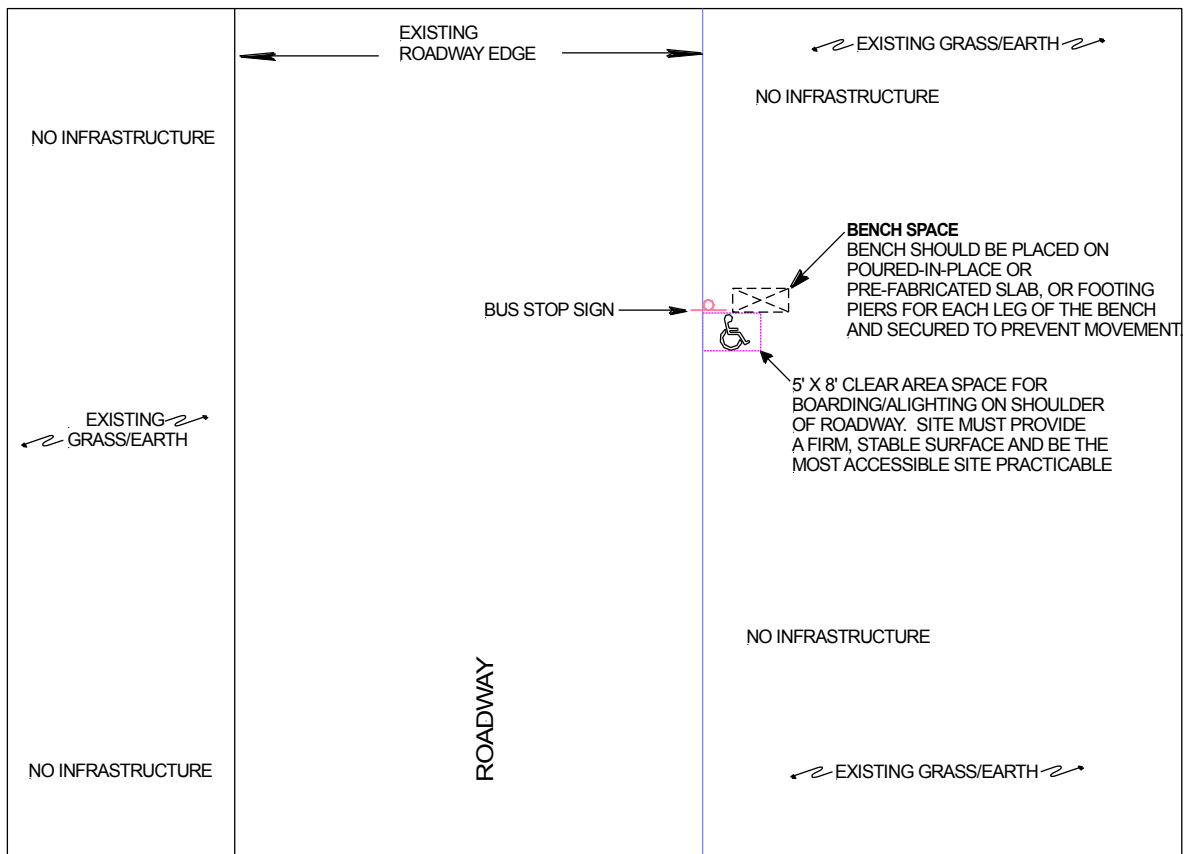

SCENARIO 4: RURAL ENVIRONMENT WITH GRASS/EARTH ALONG CURB/ROADWAY EDGE AND NO AREA AVAILABLE FOR BOARDING/ALIGHTING DUE TO RAVINE, SWALE, OVERGROWTH, OR OTHER OBSTRUCTIONS OR STRUCTURES PREVENTING SPACE FOR PASSENGERS TO MANEUVER OR BOARD BUS - NO EXISTING WALKWAY OR INFRASTRUCTURE AT STOP SITE OR OTHER RIGHT-OF-WAY ABUTMENTS.

Given this scenario, a more suitable location must be identified to establish a bus stop unless site conditions and traffic patterns allow the bus to stop in the roadway and board or alight passengers directly onto an existing shoulder meeting the boarding and alighting area requirements of the ADA. Otherwise, the site will have to be improved or another site chosen for the stop.

Without infrastructure support such as walkways, curb ramps, crosswalks, pedestrian or vehicle control devices, or other forms of pedestrian rights-of-way amenities (except for the paved boarding and alighting area), passengers are at risk whenever entering into the environment described in this scenario as it is assumed that the roadway shoulder provides the pathway to and from the bus stop. However, in certain instances, particularly in undeveloped rural areas, the establishment of public transit services may serve the best interest of the community. Given this condition, bus stop sites must be selected to provide the most accessible environment possible.

Figure A.2.5 Bench Placement Scenario Four

Appendix—DESIGN STANDARDS & SCENARIOS

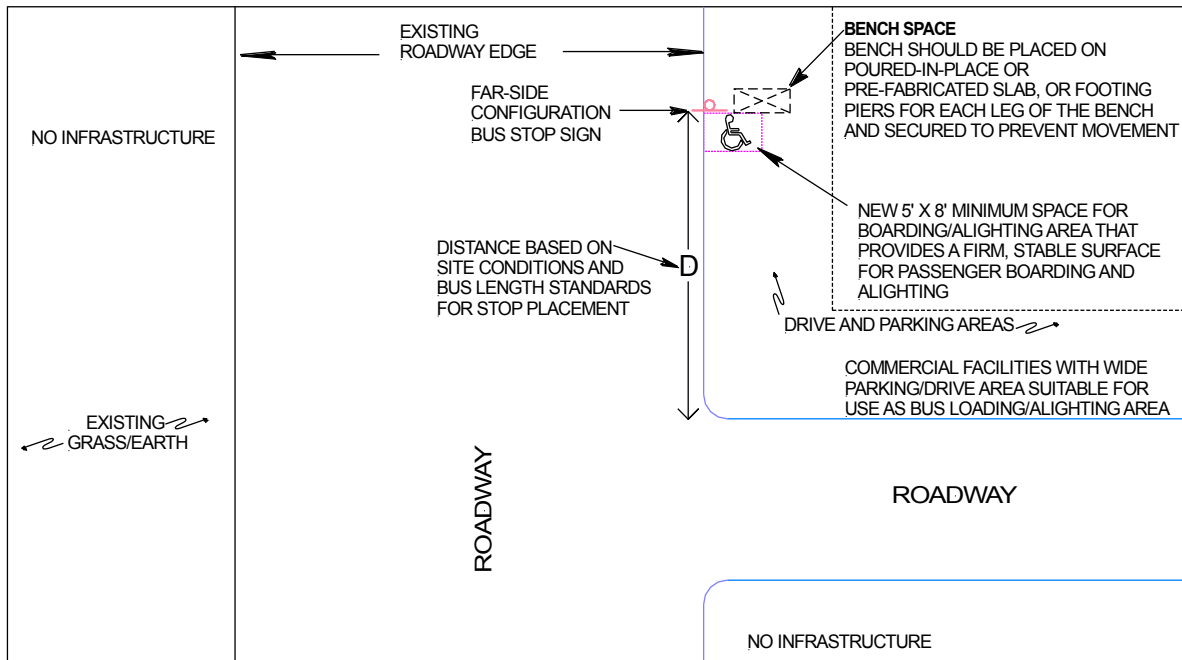

SCENARIO 5: RURAL ENVIRONMENT WITH NO EXISTING WALKWAY OR INFRASTRUCTURE NEAR PROPOSED STOP SITE OR OTHER RIGHT-OF-WAY ABUTMENTS. PLACEMENT OF STOP WITHIN EXISTING PAVED COMMERCIAL DRIVE/PARKING AREA.

This scenario solution can be applied at suburban or rural environments where no infrastructure exists and no pedestrian pathways have been established formally or informally except at site abutting commercial space.

Without infrastructure support such as walkways, curb ramps, crosswalks, pedestrian or vehicle control devices, or other forms of pedestrian rights-of-way amenities (except for the paved boarding and alighting area), passengers are at risk whenever entering into the environment described in this scenario as it is assumed that the roadway shoulder provides the pathway to and from the bus stop. However, in certain instances, particularly in undeveloped rural areas, the establishment of public transit services may serve the best interest of the community. Given this condition, bus stop sites must be selected to provide the most accessible environment possible.

Placement of a bench at sites where undeveloped and non-accessible connections to the bus stop are not provided are not recommended. However, in good faith to provide seating at these stops, placement of benches must also be accomplished in the interest of providing the most accessible placement arrangement possible. Direct connection to the paved boarding and alighting area is required to afford access to the bench by individuals with disabilities.

Figure A.2.6 Bench Placement Scenario Five

Appendix B: Joint Development Agreement Template

(To be added when provided by Votran)

Appendix C: Land Development Code Matrix

Land Development Code Review

Jurisdiction	Applicable Code	Reference
Volusia County	Large scale retail development with one or more retail tenants of 75,000 gross square feet or more and adjacent to an arterial street, which is or may be used as a transit route, shall provide on-site accommodations for public transit access, including a bus pullout and shelter. All other such developments shall anticipate the need for public transit access and shall provide bus pullouts as warranted.	Section 72-303 Non-Residential Development Design Standards
	Mass transit requirements. Community and regional shopping centers shall be designed to accommodate buses for convenient and safe boarding and unloading of passengers as well as maintaining a safe traffic pattern. Shopping centers of greater than 100,000 square feet of gross leasable floor area shall provide a passenger shelter or covered benches.	Section 72-286 Off-Street Parking and Loading
Daytona Beach	Access Layout and Design. The vehicular access and circulation system of a development located on a site abutting an existing or planned transit route shall accommodate a transit stop and other associated facilities unless the City staff determines that adequate transit facilities already exist to serve the needs of the development.	Section 6.3 Mobility and Access
	To obtain the right to a particular incentive, development shall provide the minimum number of associated sustainable development features from both schedule A and schedule B in the table.	Section 6.20 Sustainable Development Incentives.

Minimum Number of Sustainable Development Practices Provided		
Type of Incentives	From Schedule A	From Schedule B
A density bonus of up to one additional dwelling unit per acre beyond the maximum allowed in the base zoning district	2	4
An increase in the maximum allowable height by up to one story or ten feet beyond the maximum allowed in the base zoning district	2	3

An increase in the maximum allowable lot coverage by 10 percent beyond the maximum allowed in the base zoning district	2	3
A reduction from the minimum parking space requirements by 15 percent, or an increase to the maximum allowable number of parking spaces provided by 15 percent	2	2
An increase in the maximum allowable sign area or maximum height for wall or freestanding signs by 10 percent	1	3
A reduction in the amount of required open space set-aside by 10 percent	1	2

Water Conservation and Quality Protection – Sustainable Development Practices, including the provision of on-site transit facilities (e.g., designated park-and-ride parking spaces, bus shelters, or similar features). This is a schedule B practice.

Reduced Parking Requirements for Parking Demand Reduction Strategies.

1. Transit Accessibility. The City staff may authorize up to a ten percent reduction in the minimum number of off-street parking spaces required by Table 6.2.C.1, Minimum Number of Off-Street Parking Spaces, for uses located within 1,000 feet of a bus or rapid transit stop.

Section 6.2 Off-Street Parking and Loading

City staff may authorize up to a 15 percent reduction in the minimum number of off-street parking spaces for non-residential or mixed-use developments having a floor area of at least 25,000 square feet when a Transportation Demand Management (TDM) plan is developed and includes at least three TDM activities. Some activities may include formation of carpooling, vanpooling, ridesharing, guaranteed ride home, teleworking, and shuttle service programs. If the TDM plan is terminated by the applicant and/or successors or the TDM annual reports are not submitted to City staff in a timely fashion, the TDM plan shall be considered terminated. Any such termination of the TDM plan does not negate the obligations of the land owner/developer to comply with parking requirements and thus shall constitute a violation of the Code.

Special Facilities for Bicycle Commuters. The City staff may authorize up to a five percent reduction in the minimum number of off-street parking spaces required by Table 6.2.C.1,

Minimum Number of Off-Street Parking Spaces, for developments that provide both of the following:

1. A proportionate percentage reduction in vehicle spaces for bicycle parking spaces provided up to a five percent maximum. For example, if 50 vehicle spaces are required, a four percent reduction in vehicle spaces (two spaces) is permitted if two bicycle spaces are provided; and
2. Shower and dressing areas for employees.

Other Eligible Alternatives. The City staff may authorize up to a ten percent reduction in the minimum number of off-street parking spaces required by Table 6.2.C.1, minimum number of off-street parking spaces, in exchange for any other strategy that an applicant demonstrates will effectively reduce parking demand on the site of the subject development, provided the applicant also demonstrates that the proposed development plan will do at least as good a job in protecting surrounding neighborhoods, maintaining traffic-circulation patterns, and promoting quality urban design as would strict compliance with the otherwise applicable off-street parking standards.

Bus stops, bus stands, taxicab stands and stands for other passenger common carrier motor vehicles on the public streets and roadways shall be designated only by action of the city commission upon recommendation of the traffic engineer

Section 94-7
Designation of Public
Carrier Stands

Daytona Beach Shores	None	
Holly Hill	Recognizing the benefits of increased land use diversity, efficiency, and site planning, the city may allow for the reduction in required parking, a 50 percent density bonus for residential units, and an increase in building heights to a maximum of 45 feet during approval of the preliminary plan and preparation of a development agreement. However, transit is not listed as one of the performance standards contributing to the bonuses.	Section 114-630.10 Development incentives
	Prohibited signs include those placed upon benches, bus shelters, or waste receptacles, except as may be authorized in writing pursuant to F.S. § 337.407.	Section 110-6 Prohibited signs.

<p>Ormond Beach</p>	<p>Transit facilities within the right-of-way. No bus shelter shall be erected on any public right-of-way without the prior authorization of the city engineer. A right-of-way utilization agreement acceptable to the city attorney shall be required prior to issuance of any permit.</p> <p>Access and parking requirements. Due to transit availability, and the existence of on-street parking and public parking lots in the River District, the first two thousand (2,000) square feet of floor area for any new development within the River District shall be exempt from the minimum parking requirements as calculated in section 3-26. In all other districts (ocean and creek) such parking may be reduced by twenty-five percent (25%) due to transit availability.</p> <p>The following is a checklist of elements that should be incorporated into all new developments or transportation projects in the city’s downtown CRA.</p> <ol style="list-style-type: none"> Provide sidewalk easements to expand the existing width of the current sidewalk on Granada Boulevard to eleven feet (11'), thus providing pedestrian safety as well as landscaping opportunities. Provide sufficient rights-of-way (fifty-foot (50') width) on all other side streets to ensure required sidewalk width (five feet (5') wide, both sides); on-street parking (eight and one-half feet (8½') wide, both sides), two (2) eleven-foot (11') wide through lanes; and two and one-half-foot (2½') curb and gutter on both sides is accommodated. The additional five-foot (5') setback shall be used to widen the sidewalk through dedication of a public easement. Include bicycle facilities on local access roadways and retrofit existing roadways with major reconstruction projects where feasible and without loss of on-street parking. In lieu of concurrency, all new development and redevelopment shall contribute in the form of a fee to be used towards multimodal improvements such as pedestrian sidewalks, bicycle trails and enhancements, and facility/operational improvements along the transit corridors. Provide full accessibility to all, including kids, seniors and people with disabilities. <p>An applicant may provide for traffic mitigation in an effort to reduce, divert or otherwise modify estimated trips and other traffic impacts on the evaluated and affected part of the traffic circulation system and/or by increasing capacity. Acceptable mitigation relating to</p>	<p>Section 3-32 Transit facilities</p> <p>Section 2-70 Downtown Overlay District</p> <p>Section 1-32 Criteria for determining capacity.</p>
----------------------------	---	---

	transit includes, but is not be limited to subsidization of fixed-route, flexible fixed route, express bus service, and paratransit service.	
	Planned Residential Development District applications involving land in the R-4, R-5, and R-6 zoning districts shall be subject to the following in lieu of the standards contained in Section 2-35. Parking standard. In lieu of the general parking standards and subsection (f) of Section 2-35, the number of dwellings is limited by the requirement of one and one-half (1½) spaces per unit. If located on a transit route, the parking standard may be reduced to one (1) space per unit.	Section 2-35 Planned Residential Development District
	Applications for Planned Business Development (PBD) District rezoning shall provide a minimum of two of the public benefits listed in Section 2-36 or propose alternative public benefits which are acceptable to the city commission. For each variance requested, an additional two public benefit items shall be required. Public benefits listed include providing a sheltered bus stop (only if an existing bus stop exists on site and Votran provides approval) or adopting a transit route that is closest to the site in question by contributing funds to offset the operating costs of the route as determined in the PBD..	Section 2-36 Planned Business Development District
Ponce Inlet	Planned waterfront development should include an integrated system of public access to the river, including walks and paths in the riverfront area that promote walkability and the use of bicycles and public transit.	Section 10.1.9 Planned Waterfront Development
	Parking space reduction. The town council may approve requests to allow fewer parking spaces than the minimum number required under circumstances included in Section 4.7.8m including if the use is located within 500 feet of a transit stop and a portion of the demand is expected to be met by transit. All such requests shall be accompanied by supporting documentation, including professionally recognized standards or professionally prepared studies.	Section 4.7.8 Minimum number of off-street parking spaces
	Bus stop information signs up to four square feet in area shall be allowed in all districts. These signs shall have a maximum height of four feet unless otherwise required by applicable law.	Section 3.30.6 District sign regulations
Port Orange	Transportation improvements required. Bus stops - New commercial developments exceeding 50,000 square feet in gross floor area and all new residential developments of	Section 2 General provisions

more than 200 dwelling units shall provide on-site space for bus stops if located on an existing or proposed bus route. Such bus stops shall be separate and adjacent to travel lanes.

Function of landscape materials. Landscape materials required by the Supplemental Landscaping Section should be located to enhance walkways, entrances, seating areas, bus stops, or any other pedestrian areas in order of priority listed in the corresponding section.

Section 5
Supplemental
Landscaping

Transportation concurrency exception area (TCEA) mobility enhancements. The TIA shall identify and analyze the multi-modal mobility enhancements that the developer intends to utilize to address impacts of the development, including but not limited to, new or expanded public transit facilities, community trolley/shuttle facilities and services, water-taxi facilities and services, and new or enhanced roadway system networks, bike paths and sidewalks, including the Riverwalk Boardwalk/Urban Trail.

Section 30 Planned
community—Port
Orange Riverwalk
(PC-R) district

Additionally, all developments shall be required to adhere to the "complete streets" policy (Policy 4.1.9 of the Transportation Element of the Comprehensive Plan). All developments shall provide the following as required by the city:

1. Safe and convenient on-site pedestrian circulation such as sidewalks and crosswalks connecting buildings, parking areas and existing or planned public sidewalks;
2. Cross-access connections/easement and/or joint driveways;
3. Dedication of land and/or easements for the construction of public sidewalks and mass-transit facilities;
4. Project entrances, bus shelters, bicycle facilities, sidewalks, and streetscape enhancements.

South Daytona

Bus benches and shelters. Nothing contained in the Code shall be construed to prohibit the placement or construction of bus benches or bus shelters in connection with public transportation and from the painting or attachment of signs thereto; provided, however, that such bus benches and bus shelters upon which signs are painted or attached shall be placed or constructed under and pursuant to the terms of a license agreement or other contract executed on behalf of the city wherein the conditions concerning the placement, design, construction, number and signage connected with such bus benches and bus shelters, as applicable, shall be set forth.

Section 8.2 Sign
regulations

	The city allows incentives as a reduction in parking and a 50 percent density bonus for residential units during approval of the final site plan and preparation of a development agreement. However, transit is not listed as one of the performance standard bonuses.	
New Smyrna Beach	The number of parking spaces required may be reduced by one when the bicycle parking is provided on-site in accordance with the bike space reduction table provided in Section 26-1106.	Section 26-1106 Planned Development Incentives
Edgewater	None	
Oak Hill	The following signs are expressly prohibited unless exempted by section 24-727 or expressly authorized by divisions 4, 5 or 6 of this article: (20) Signs placed upon benches, bus shelters or waste receptacles, except as may be authorized in writing pursuant to F.S. § 337.407.	Section 24-754 Specific prohibition.
DeBary	The Transit Oriented Development Overlay District is an incentive-based option and is not required.	Article VI Southeast Mixed-Use Area/Transit Oriented Development (SEMUA/TOD) Overlay District Standards
	Ensure that the design and construction of ground-floor building space near transit, at visible intersections, and along key streets that lead to transit, accommodate for active pedestrian-oriented uses even though these types of uses may not be supported by current market conditions.	Section 5-134 Building Design Standards
	Bus stops. Bus stop needs and design shall be coordinated with VOTRAN.	
	<ol style="list-style-type: none"> 1. In addition to VOTRAN requirements individual site plans shall consider the following: 2. Bus stops shall be evaluated for need every 660 feet from the final design site of the DeBary Commuter Rail Station. 3. Bus stops may be accommodated via provision of additional property either on street adjacent to the right-of-way or via dedicated area within an off-street parking area. 	Section 5-133 Site Development Standards

4. Within the TOD Core bus stops shall incorporate a shelter area of no less than 24 square feet including seating.
5. Outside of the TOD Core bus stops shall include bench seating. Shelter area is optional.
6. Bus stops shall comply with any architectural standards as established by the city.
7. Bus stops within the TOD Core area shall include provision for secure bicycle parking in accordance with subsection 5-133(b) (9 h).

Mass transit requirements. Community and regional shopping centers shall be designed to accommodate buses for convenient and safe boarding and unloading of passengers as well as maintaining a safe traffic pattern. Shopping centers of greater than 100,000 square feet of gross leasable floor area shall provide a passenger shelter or covered benches.

Section 3-129 Off-street parking and loading.

DeLand

To avoid requiring more parking spaces than actually needed to serve a development, the city commission may defer the provision of some portion of the off-street parking spaces required by this section if the conditions and requirements listed below and those included in subsections 2 through 7 are satisfied.

Section 33-91 Off-street parking and loading

2. As a condition precedent to obtaining a partial deferral by the city commission, the developer must show any one or more of the following:

- a. A parking study as described in section 33-91.01(d) of this section indicates that there is not a present need for the deferred parking.
- b. Public transportation satisfies transportation demands for a portion of the users of the facility that corresponds to the amount of parking sought to be deferred.
- c. The developer has established or will establish an alternative means of access to the use that will justify deferring the number of parking spaces sought to be deferred. Alternative programs that may be considered by the city commission include, but are not limited to:
 - (1) Private and public car pools and van pools.
 - (2) Charging for parking.
 - (3) Subscription bus services.
 - (4) Flexible work-hour scheduling.
 - (5) Capital improvement for transit services.
 - (6) Ride sharing.
 - (7) Establishment of a transportation coordination position to implement car pool, van pool, and transit programs.

- (a) Nonmotorized transportation. The percentage of parking spaces sought to be deferred corresponds to the percentage residents, employees, and customers who regularly walk, use bicycles and other nonmotorized forms of transportation, or use mass transportation to come to the facility.
- (b) On-street parking. The percentage of parking spaces sought to be deferred corresponds to the percentage of vehicles that may be accommodated by on-street parking within 200 feet of the development.
- (c) Transportation system management. An alternative method of transportation designed to address the short term transportation system needs through more efficient use of existing transportation facilities.
- (d) Transportation demand management. A transportation planning process that is aimed at relieving congestion on highways by following several types of actions: (1) actions that promote alternative automobile use; (2) actions that encourage more efficient use of alternative transportation systems; and (3) action that discourages automobile use.

Medical uses are high traffic generating uses. Reducing the number of trips to the development creates a benefit to the city through less demand on the transportation system. The employee parking component of each use may be reduced by up to 20 percent if the employer establishes a permanent commuter trip reduction program that offers employees incentives such as transit passes, shuttle services, car pool incentives or other similar programs to reduce the number of single occupant vehicles traveling to and from the site.

Section 33.37
Medical Services
Overlay District

Bicycle parking. To facilitate the lessening of car-related congestion in the city and to promote the use of alternative modes of transportation, to provide for general health and fitness and to promote air quality and reduce pollution, the accommodation of bicycle commuting is required through the provision of adequate and safe facilities for the storage of bicycles. Further, as specified by this section, a reduction in required automobile parking spaces is allowed when bicycle parking is provided, creating an incentive for providing bicycle parking in accordance with the provisions of this chapter.

Section 33-91 Off-
street parking and
loading

Bus stops and other similar structures are allowed as accessory structures in all zoning districts.

Section 33-28
Accessory structures

(b) Standards. Bus stops and similar structures may be erected only if in compliance with the following standards:

1. Bus stops shall be permitted in front or side setback areas. They may also be allowed inside the required landscape buffers.
2. Bus stop area may not exceed 200 square feet.
3. Exterior appearance shall be compatible with principal building's exterior.

The following signs are expressly prohibited unless exempted by section 33-72 of this article or expressly authorized by section 33-22 of article II, section 33-74, section 33-75, or section 33-76 of this article:

Signs placed upon benches, bus shelters or waste receptacles, except as may be authorized in writing pursuant to § 337.407, Florida Statutes.

Section 33-73
Prohibited Signs

Deltona

Community and regional shopping centers shall be designed to accommodate buses for convenient and safe boarding and unloading of passengers as well as maintaining a safe traffic pattern. Shopping centers of greater than 100,000 square feet of gross leasable floor area shall provide a passenger shelter or covered benches to accommodate the mass transit system riders. Bus stops, shelters, and benches shall be designed so as to avoid interference with automobile and pedestrian traffic from mass transit operations and facilities.

Section 110-828 Off-street parking and loading

Accordingly, nothing contained in this chapter shall be construed to prohibit the placement or construction of bus benches or bus shelters in connection with public transportation and from the painting or attachment of signs thereto; provided, however, that such bus benches and bus shelters upon which signs shall be painted or attached shall be placed or constructed under and pursuant to the terms of a license agreement or other contract executed on behalf of the city wherein the conditions concerning the placement, design, construction, number and signage connected with such bus benches and bus shelters, as applicable, shall be set forth.

Section 102-105 Bus benches and shelters

On-site improvements. A developer shall be required to construct or escrow for the construction of those on-site improvements required by the provisions of this section and any additional improvements necessary for traffic safety, including but not limited to the following: pavement, rock base, fill, curbs, gutters, sidewalks, bikeways, guardrail, shoulder areas, swales, roadside recovery areas, bridges, drainage outlets, catch basins, drainage

Section 96-38 Design standards and requirements for local streets

pipes, culverts, drainage ditches, head walls, end-walls, riprap, traffic signals and interconnecting facilities, traffic control signs and roadway markings, street name signs, identification signs, left-and right-turn lanes, median openings, bus turnouts, and traffic separators.

Lake Helen	None	
Orange City	<p>Signs identified in this section are prohibited and shall be removed immediately in accordance with this chapter. In addition to the list below, any sign or commercial message that is not expressly permitted in the text of this chapter shall be prohibited.</p> <p>Signs on bus benches, bus canopies or any other public or private multi-modal, pedestrian, bicycle or transit facility, including any associate street furniture or equipment.</p> <p>Community and regional shopping centers shall be designed to accommodate buses for convenient and safe boarding and unloading of passengers as well as maintaining a safe traffic pattern. Commercial centers of greater than 100,000 square feet of gross leasable floor area shall provide a passenger shelter or covered benches.</p>	<p>Section 9.4 Prohibited Signs</p> <p>Section 8.7 Supplementary regulations.</p>
Pierson	<p>The following signs are expressly prohibited unless exempted by Section 9.2 of these Regulations or expressly authorized by Sections 9.4, 9.5, or 9.6 of these Regulations:</p> <p>Signs placed upon benches, bus shelters or waste receptacles, except as may be authorized in writing pursuant to s. 337.407, Florida Statutes.</p> <p>Signs that are exempt include: advertising and identifying signs located on taxicabs, buses, trailers, trucks, or vehicle bumpers.</p>	<p>Section 9.3 Prohibited Signs</p> <p>Section 9.2 Exempt Signs</p>

Appendix D: Supplemental Design Standards

Bus Bays

Examples of an open bus bay and queue jump bus bay are shown in the figures below. An open bus bay for a 40-foot bus with a design speed of 40 miles per hour consists of a 50-foot stop area for one bus and a 400-foot acceleration lane. Queue jump bus bays are effective for far-side open bus bays on high-frequency bus service routes on streets with traffic volumes of 250 vehicles per peak-period hour or level of service D or worse.



Open bus bay design



Queue jump bus bay design

Accessing Transit: Design Handbook for Florida Bus Passenger Facilities, Version III, 2013

Bus Stop Sign & Pole

The table below presents the required bus stop sign visual character heights based on the height of the sign and the horizontal viewing distance.

Height to Finish Floor or Ground from Baseline of Character	Horizontal Viewing Distance	Minimum Character Height
40" to less than or equal to 70"	Less than 72"	5/8"
	72" and greater	5/8", plus 1/8" per foot of viewing distance above 72"
Greater than 70" to less than or equal to 120"	Less than 180"	2"
	180" and greater	2", plus 1/8" per foot of viewing distance above 180"
Greater than 120"	Less than 21'	3"
	21' and greater	3", plus 1/8" per foot of viewing distance above 21'

Accessing Transit: Design Handbook for Florida Bus Passenger Facilities, Version III, 2013

Appendix E: TIA Process Flowchart

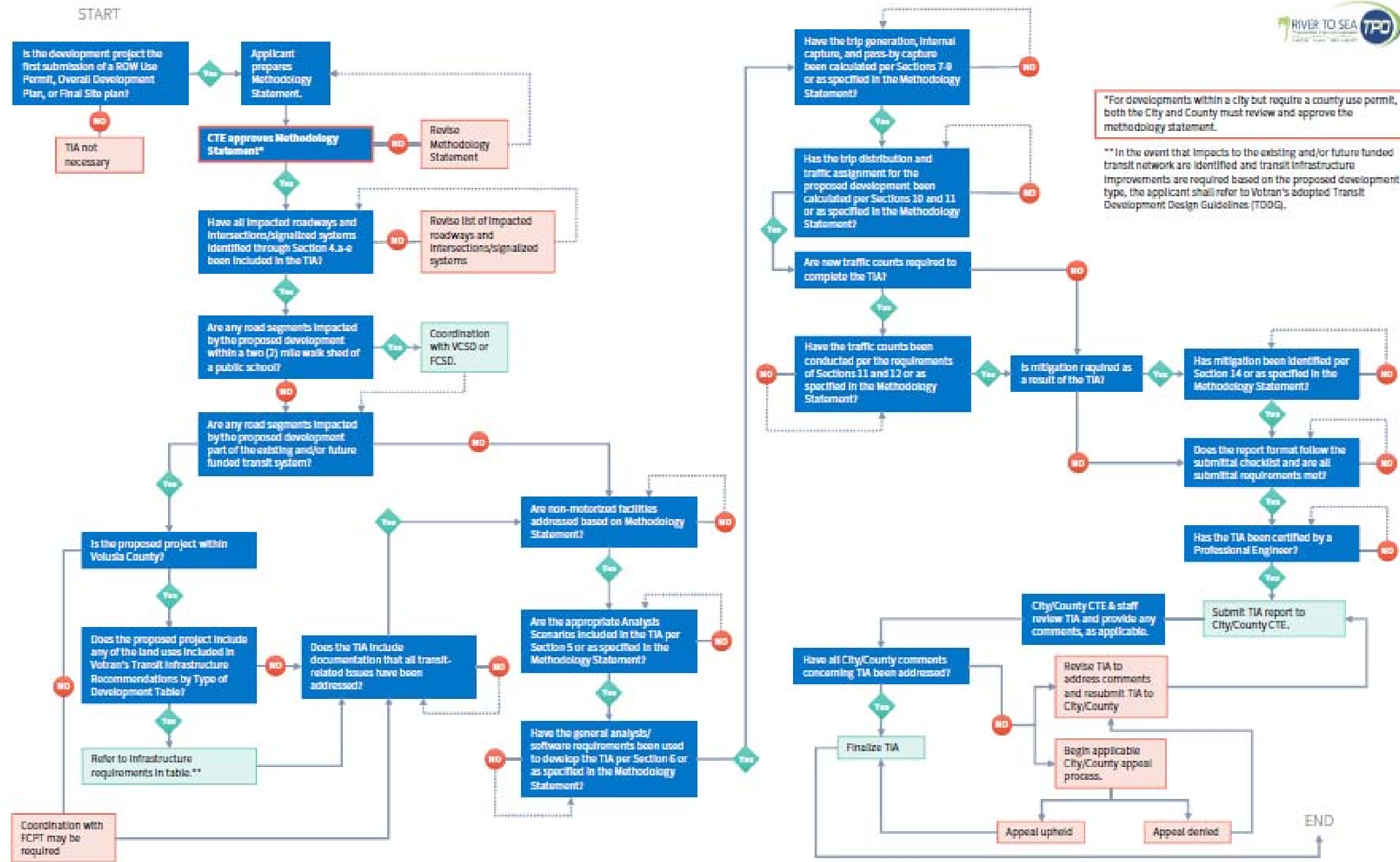

*For developments within a city but require a county use permit, both the City and County must review and approve the methodology statement.

** In the event that impacts to the existing and/or future funded transit network are identified and transit infrastructure improvements are required based on the proposed development type, the applicant shall refer to Voltran's adopted Transit Development Design Guidelines (TDDG).

■ Process Step
 ■ Next Action Stemming from a Yes
 ■ Next Action Stemming from a No

TIA Methodology Process

Appendix F: Reference Sources

1. Plans Preparation Manual (PPM): <http://www.dot.state.fl.us/rddesign/PPMManual/PPM.shtm>
2. Florida Design Standards: <http://www.dot.state.fl.us/rddesign/DS/17/STDs.shtm>
3. ADA & ABA Accessibility Guidelines: <http://www.access-board.gov/guidelines-and-standards>
4. Florida Greenbook: <http://www.dot.state.fl.us/rddesign/FloridaGreenbook/FGB.shtm>
5. Manual on Uniform Traffic Control Devices (MUTCD): <http://mutcd.fhwa.dot.gov/index.htm>
6. Traffic Engineering Manual – Procedural:
<http://www.dot.state.fl.us/trafficoperations/operations/Studies/TEM/tem.shtm>
7. AASHTO Guide for Geometric Design of Transit Facilities on Highways and Streets’’:
<https://bookstore.transportation.org>
8. Florida Administrative Code (F.A.C.) - Chapter 14-20: <https://www.flrules.org/Default.asp>
9. FHWA Pedestrian Safety Guide:
http://safety.fhwa.dot.gov/ped_bike/ped_transit/ped_transguide/ch1.cfm
10. Florida Building Code: www.floridabuilding.org
11. Florida Accessibility Code (FAC) Chapter 11
12. Accessing Transit Handbook, Version III, 2013:
<http://www.dot.state.fl.us/transit/Pages/NewTransitFacilitiesDesign.shtm>
13. FDOT State Park-and-Ride Guide:
<http://www.dot.state.fl.us/transit/Pages/FinalParkandRideGuide20120601.pdf>.
14. American Public Transportation Association, Crime Prevention Through Environmental Design (CPTED) for Transit Facilities: <http://www.apta.com/resources/standards/Documents/APTA-SS-SIS-RP-007-10.pdf>